

# RS Tera 5.3 - Fitting the Performance Downhaul

## Contents:

plastic bobble



block on d12 rope with loop

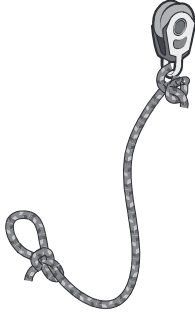

D12 rope with loop

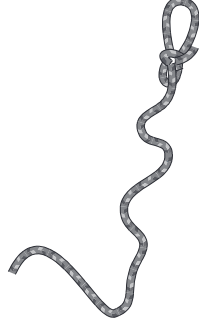

block on d12 rope with cow hitch



downhaul rope



a)

Take the D12 rope with the block cow hitched to it and tie it around the mast, through the bottom deck eye (the same one as the kicker mast tie).

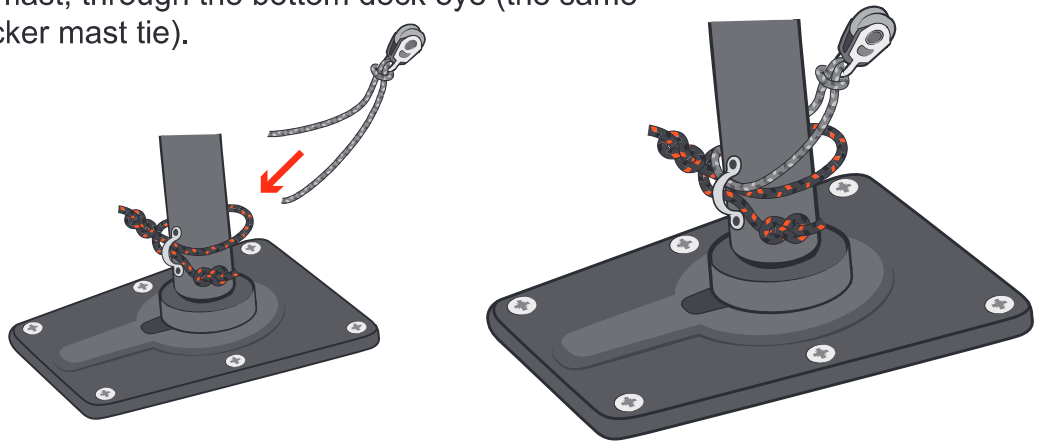

b)

Take the D12 rope with loop and pass the free end around the mast (just below the boom gooseneck joint) and then back through the loop

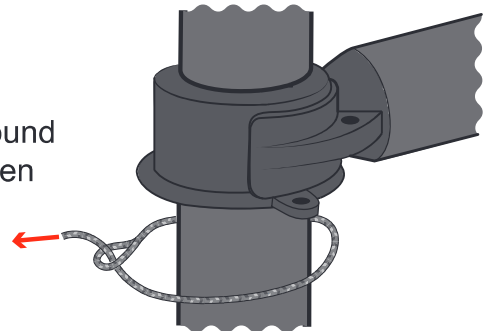

c)

Pass the tail of the D12 up through the hole in the gooseneck collar.

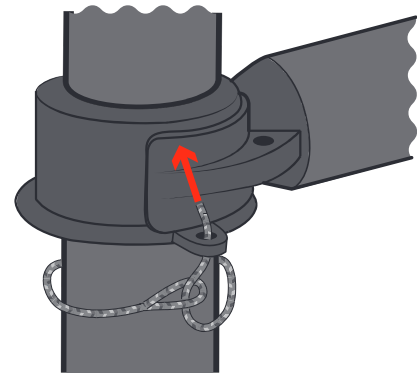

**5.3 - Fitting the Performance Downhaul**

d)

Slide the plastic bobble onto the D12 and tie a half hitch in the tail close to the gooseneck .

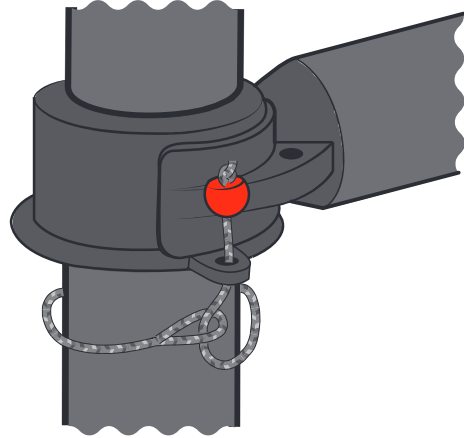

Cut off any excess tail and seal the end.

e)

Take the remaining block (on D12 rope with loop at the end).

Tie one end of the downhaul rope through the centre hole of the block.



f)

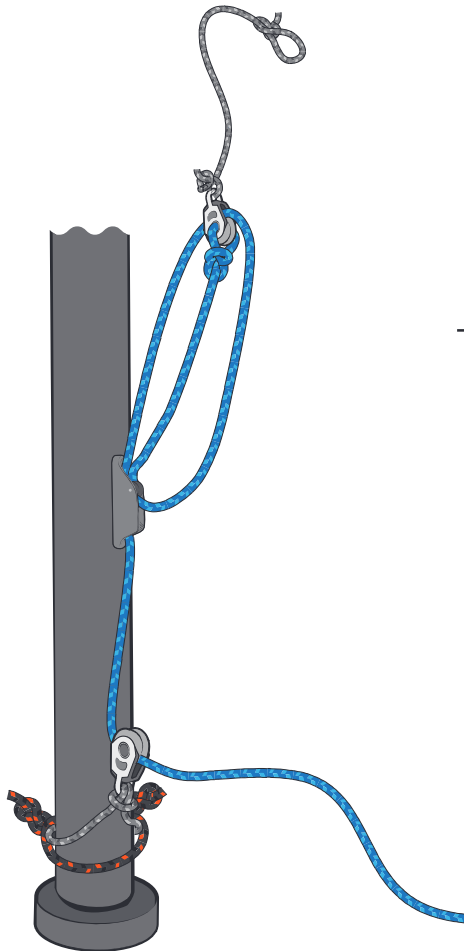

Thread up the purchase as shown.

g)

Pass the loop on the end of the D12 up through the cringle on the sail.

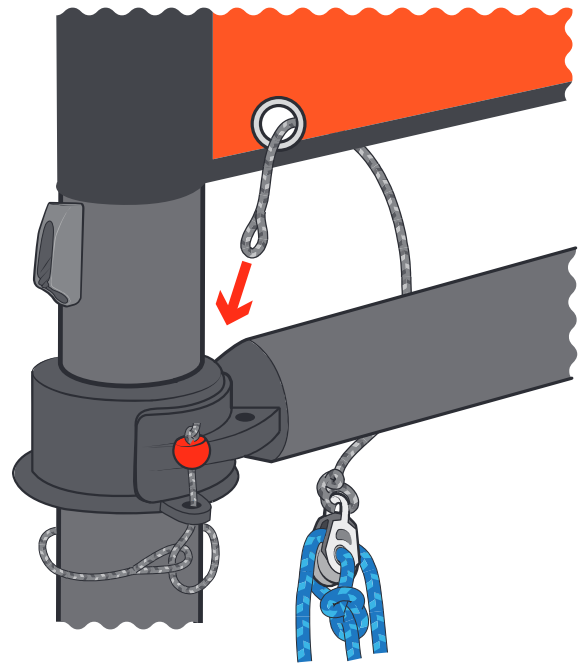

h)

Hook the rope loop over the plastic bobble.

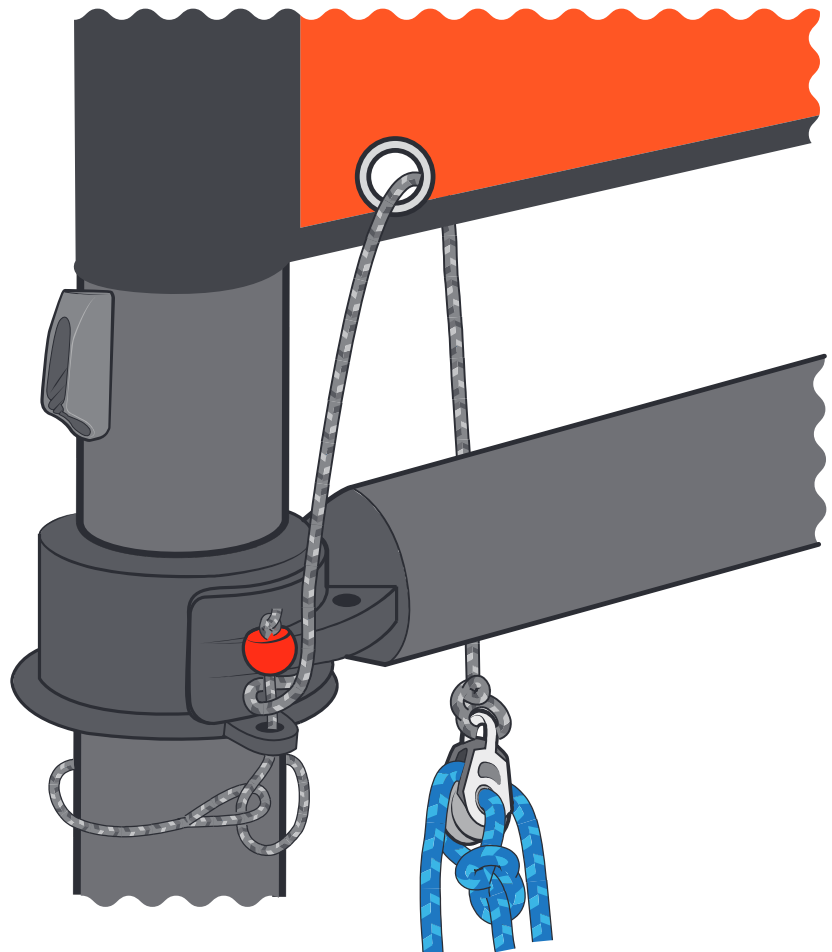

The performance downhaul is now ready to use.