

# RS 500

## Rigging Manual V1



PLEASE FOLLOW RIGGING MANUAL IN THE CORRECT ORDER



# RS 500

# Contents

|   |                |
|---|----------------|
| <b>1. Introduction .....</b>                  | <b>1</b>       |
| <b>2. Preparation .....</b>                   | <b>2 - 21</b>  |
| 2.1 - Preparation .....                       | 3              |
| 2.2 - Unpacking .....                         | 3              |
| 2.3 - Pack contents .....                     | 4-5            |
| 2.4 - Adding the shroud adjusters.....        | 6              |
| 2.5 - Adding the spinnaker ratchets .....     | 6 - 7          |
| 2.6 - Adding the spinnaker chute bar .....    | 7 - 8          |
| 2.7 - Rig tension.....                        | 8 - 10         |
| 2.8 - Kicker .....                            | 10 -11         |
| 2.9 - Trapeze elastic .....                   | 12             |
| 2.10 - Spinnaker pole .....                   | 12 - 13        |
| 2.11 - Spinnaker chute elastic .....          | 14             |
| 2.12 - Spinnaker ratchet elastic .....        | 14 - 15        |
| 2.13 - Centreboard retainer .....             | 15             |
| 2.14 - Centreboard handle .....               | 16             |
| 2.15 - Toe strap tie downs .....              | 16             |
| 2.16 - Toe strap elastic (rear) .....         | 17             |
| 2.17 - Spinnaker halyard take up .....        | 17 - 18        |
| 2.18 - Mainsheet rear strop .....             | 19             |
| 2.19 - Rudder .....                           | 19 - 21        |
| <b>3. Rigging the mast .....</b>              | <b>22 - 41</b> |
| 3.1 - Fitting the spreaders to the mast ..... | 23             |
| 3.2 - Spreaders .....                         | 24             |
| 3.3 - Trapeze lines .....                     | 25             |
| 3.4 - Stepping the mast .....                 | 26 - 27        |
| 3.5 - Final rig adjustments .....             | 28 - 29        |
| 3.6 - Rigging the spinnaker halyard .....     | 29 - 30        |
| 3.7 - Rigging the boom .....                  | 30 - 31        |
| 3.8 - Rigging the Jib .....                   | 31 - 33        |
| 3.9 - Rigging the mainsheet .....             | 34 - 35        |
| 3.10 - Hoisting the mainsail .....            | 35 - 37        |
| 3.11 - Mainsail tack strap .....              | 38             |
| 3.12 - Downhaul .....                         | 38             |
| 3.13 - Rigging the spinnaker .....            | 39 - 41        |
| <b>4. Completion .....</b>                    | <b>42 - 43</b> |
| <b>5. Sailing Hints .....</b>                 | <b>44 - 47</b> |
| 5.1 - Introduction .....                      | 45             |
| 5.2 - Launching .....                         | 45             |
| 5.3 - Leaving the beach .....                 | 45             |
| 5.4 - Sailing close hauled and tacking .....  | 46             |
| 5.5 - Sailing downwind and gybing .....       | 46             |
| 5.6 - Using the genacker .....                | 46-47          |
| <b>6. Maintenance .....</b>                   | <b>31 - 34</b> |
| 6.1 - Boat care .....                         | 32             |
| 6.2 - Foil care .....                         | 33             |
| 6.3 - Spar care .....                         | 33             |
| 6.4 - Sail care .....                         | 33             |
| 6.5 - Fixtures and fittings .....             | 34             |
| <b>7. Warranty .....</b>                      | <b>35</b>      |
| <b>8. Knots .....</b>                         | <b>36 - 37</b> |
| <b>9. Glossary .....</b>                      | <b>38-46</b>   |

# 1. Introduction

Congratulations on the purchase of your new RS 500 and thank you for choosing an RS product. We are confident that you will have many hours of great sailing and racing in this truly excellent design.

The RS 500 is an exciting boat to sail and offers fantastic performance. This manual has been compiled to help you to gain the maximum enjoyment from your RS 500, in a safe manner. It contains details of the craft, the equipment supplied or fitted, its systems, and information on its safe operation and maintenance. Please read this manual carefully and be sure that you understand its contents before using your RS 500.

This manual will not instruct you in boating safety or seamanship. If this is your first boat, or if you are changing to a type of craft that you are not familiar with, for your own safety and comfort, please ensure that you have adequate experience before assuming command of the craft. If you are unsure, RS, your RS dealer, or your national sailing federation – for example, the Royal Yachting Association – will be able to advise you of a local sailing school, or a competent instructor.

**Please keep this manual in a secure place and hand it over to the new owner if you sell the boat.**

**For further information, spares, and accessories, please contact:**

RS Sailing  
Premier Way  
Abbey Park  
Romsey  
Hants SO51 9DQ  
Tel.: +44(0)1794 526760  
Fax: +44(0)1794 278418  
E-mail: [www.info@rssailing.com](mailto:www.info@rssailing.com)

**For details on your local RS dealer, please visit [www.rssailing.com](http://www.rssailing.com)**

# RS 500

## 2. Preparation

Before rigging your boat for the first time there are several components which must be added. Please allow an additional 3 hours to do this before sailing. Once added, the fittings in this section can be left on the boat.



PLEASE FOLLOW RIGGING MANUAL IN THE CORRECT ORDER



# RS 500



## **RS** 500 2.1 - Preparation

Your RS 500 comes complete with all the components necessary to take the boat sailing.

In order to commission it, you will need the following tools:

- Pliers or a shackle key
- Small, flat bladed screw driver
- PVC (electricians) tape
- Cigarette lighter (to seal rope ends)
- 8mm socket or ratchet
- PZ#2 driver

You may require other tools later, should you wish to make any settings or tuning adjustments to the boat and rig.











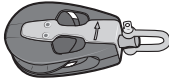







**Whilst your RS 500 has been carefully prepared, it is important that new owners should check that shackles and knots are tight. This is especially important when the boat is new, as travelling can loosen seemingly tight fittings and knots. It is also important to check such items prior to sailing regularly.**

## **RS** 500 2.2 - Unpacking

**DO NOT use a knife or other sharp object to cut through packaging containing parts – you may damage the contents!**

Having unpacked your RS 500 you should check that you have all the items listed in section 2.3 before throwing away any of the packing as there may be some small items still wrapped.

**RS**  
**500** 2.3a - Pack contents

|   | QUANTITY | COMPONENT                               |
|---|----------|---|
|    | 4        | shroud verniers                         |
|    | 2        | spinnaker ratchet blocks                |
|    | 2        | M5 machine screws                       |
|    | 2        | M5 washers                              |
|    | 2        | M5 Nyloc nut                            |
|    | 2        | M5 dome nut                             |
|    | 1        | Spinnaker chute bar                     |
|    | 1        | clam cleat (rig tension)                |
|   | 2        | forged shackle                          |
|  | 3        | 20mm plain bearing block                |
|  | 3        | 20mm ball bearing block                 |
|  | 1        | 20mm ball bearing block (fixed head)    |
|  | 2        | 30mm ball bearing block                 |
|  | 1        | plastic hook                            |
|  | 1        | 40mm mainsheet block with rope attached |
|  | 1        | rudder blade                            |
|  | 1        | rudder stock and tiller                 |
|  | 1        | tiller extension                        |
|  | 1        | boom                                    |
|  | 1        | mast                                    |

**RS**  
**500** 2.3b - Rope pack contents

|   | QUANTITY | COMPONENT                                |
|---|----------|--|
|    | 2        | spinnaker ratchet ties                   |
|    | 2        | spinnaker ratchet bungy                  |
|    | 1        | rig tension long                         |
|    | 1        | rig tension short                        |
|    | 1        | kicker control line                      |
|    | 1        | trapeze elastic bungy                    |
|   | 1        | spinnaker chute bungy                    |
|  | 1        | centre board retainer bungy              |
|  | 1        | centre board handle                      |
|  | 2        | toestrap ties                            |
|  | 1        | toestrap bungy                           |
|  | 1        | spinnaker halyard take up block retainer |
|  | 1        | rudder downhaul short                    |
|  | 1        | rudder downhaul long                     |
|  | 1        | jib sheet block tie                      |

**RS**  
**500**

## 2.4 - Adding the shroud adjusters

a)

Locate the four shroud adjusters in the fittings pack and remove the clevis pins and rings.

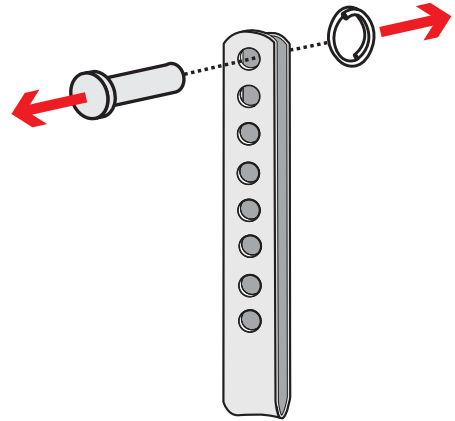

b)

Slide two shroud adjusters into place on each shroud U-bolt and reattach the pin in the top position.

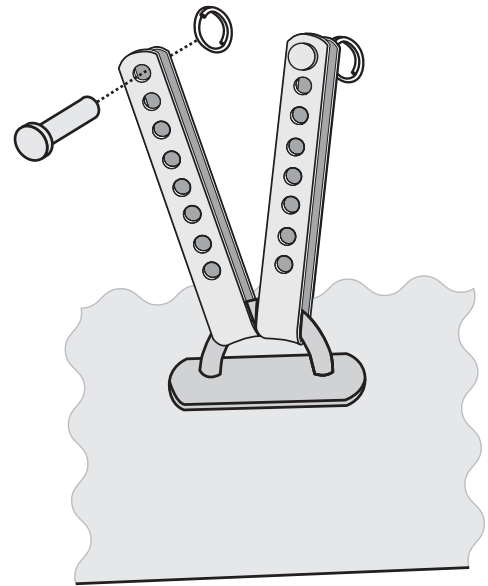

**RS**  
**500**

## 2.5 - Adding the spinnaker ratchets

a)

Locate the spinnaker ratchet blocks and spinnaker ratchet ties in the packs.

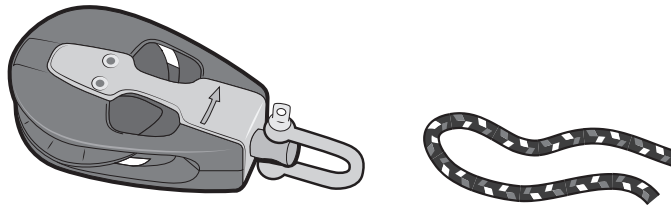

b)

Tie **knot #3** (see knot reference in **section 6.5**) in one end of the rope.



**RS**  
**500**

## 2.5 - Adding the spinnaker ratchets

c)

Pass the other end of the rope up through the front hole in the gunwhale.

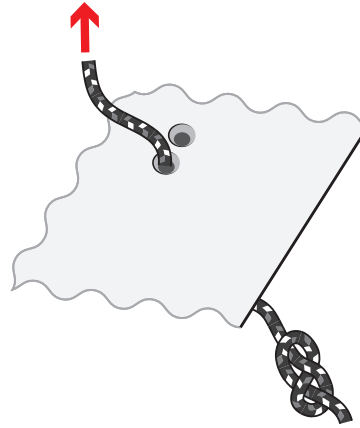

d)

Pass the rope through the fitting and back down through the rear hole.

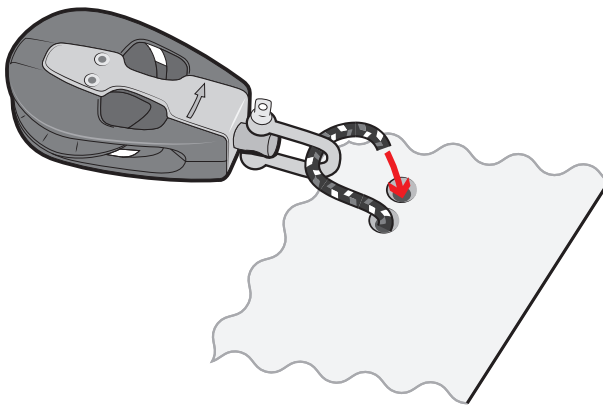

Make sure the shackle key is pointed away from the deck.

e)

Tie **knot #3** under the gunwhale as close to the rear hole as possible.

Cut and seal any excess rope.

**RS**  
**500**

## 2.6 - Adding the spinnaker chute bar

a) Locate the spinnaker chute bar fixings in the fittings pack:

• M5 x 35 Pozzi Csk Machine Screw x 2

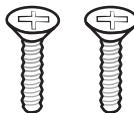

• M5 9021 Washer x 2



• M5 Nyloc x 2



• M5 Dome Nut x 2



## RS 500 2.6 - Adding the spinnaker chute bar

b)

Position the spinnaker chute bar square to the boat above the holes in the gunwhale.

Move it forwards and backwards to allow the spinnaker sock to become firmly trapped under the bar ends.

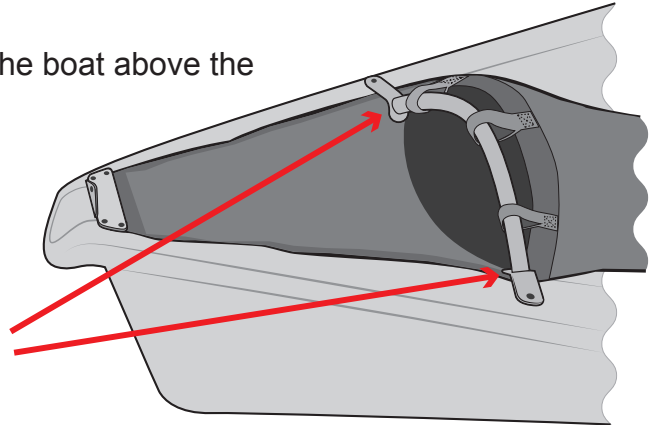

c)

Make sure the spinnaker chute is firmly trapped under the bar then fix the bar into place as shown.

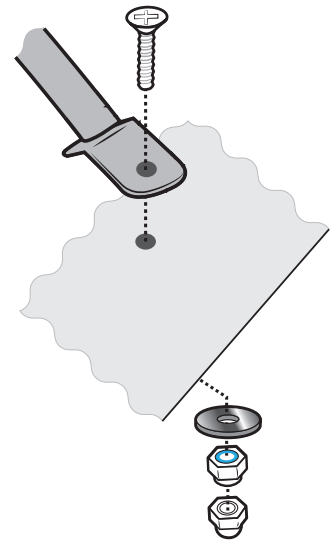

## RS 500 2.7 - Rig tension

a)

Locate the rig tensioner ropes and fittings in the packs:

• Short rope 

• Long rope 

• Clam cleat x1 

• Block x 2 

• Shackle x 2 

b)

Secure the block and shackle to the bow tack plate as shown.

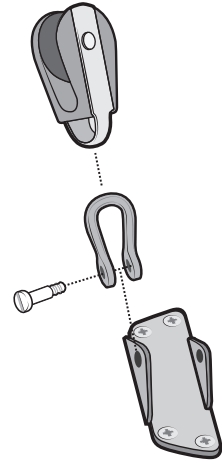
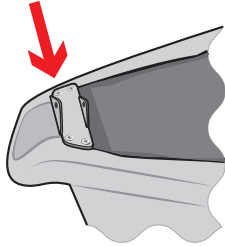

c) Tie off one end of the short rope to the shackle using **knot #1**.

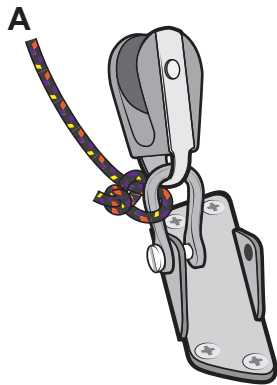

d) Pass the other end of the short rope through the other block and tie off on the Clamcleat with **knot #1**.

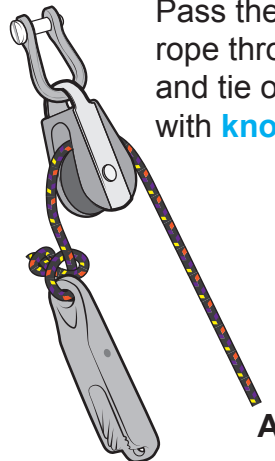

d)

Tie off the long piece of rope onto the bottom of the clam cleat with **knot #1**.

Pass it through the block on the boat and back up to the clam cleat, over the roller and into the jaws of the cleat.

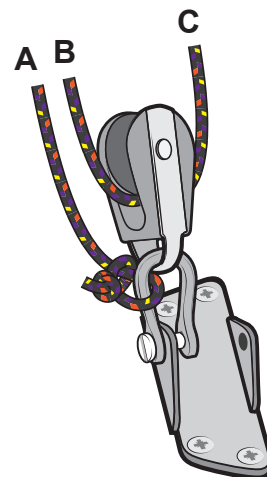
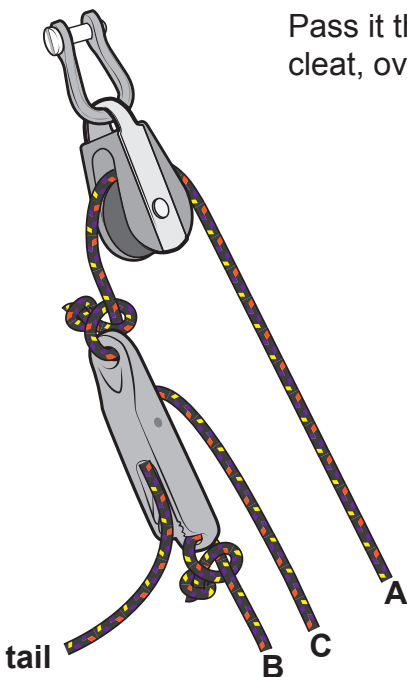

## RS 500 2.7 - Rig tension

e)

Take the tail of the rope and tie **knot #3** about 50mm from the end.

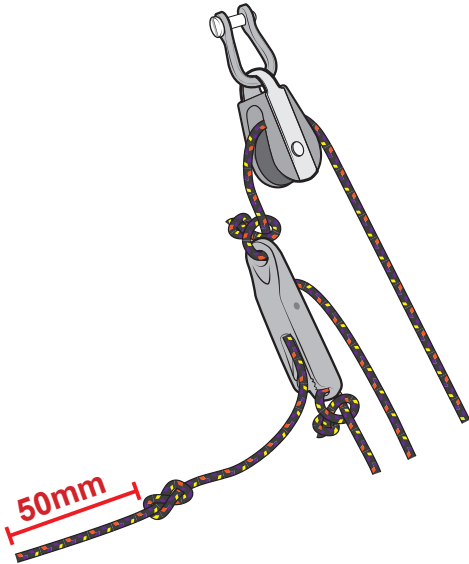

f)

Adjust the length of the purchase to 700mm bearing surface to bearing surface.



## RS 500 2.8 - Kicker

a)

Locate the kicker from the rope pack and the three kicker blocks and shackle from the fittings pack.



b)

Form a loop in the rope 1m from the end and use **knot #6** to secure the loop to the rear bolt on the mast step.

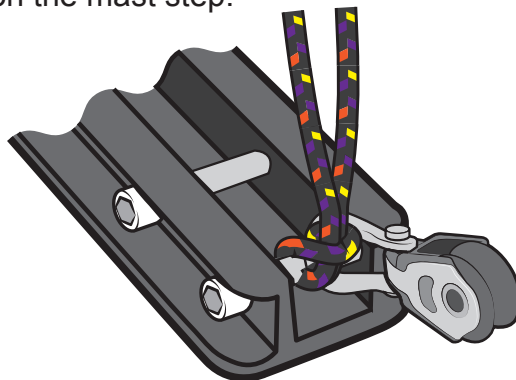



c)

Pass the short end of the rope through **block A** and attach to the top of the **block B** using **knot #1**.

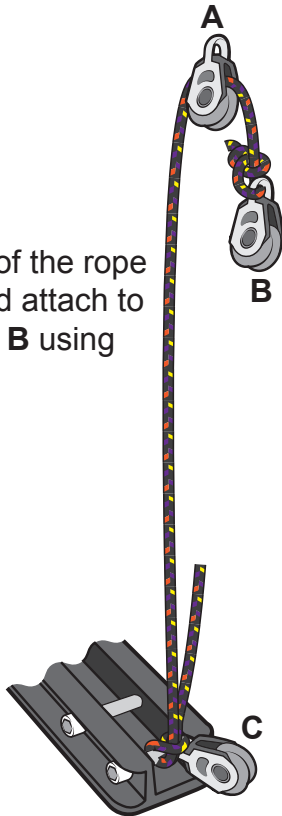

d) Pass the long end of the rope through **block B** and down to the mast step and through **block C**.

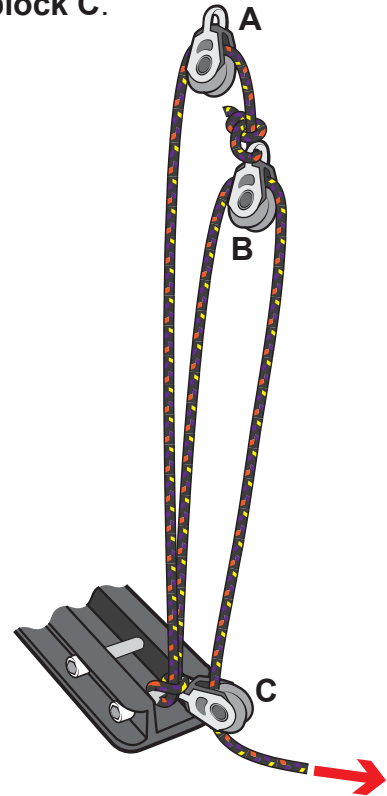

e)

Pass the end of the rope (coming from **block c**) through the kicker swivel cleat. Tie **knot #3** in the end.

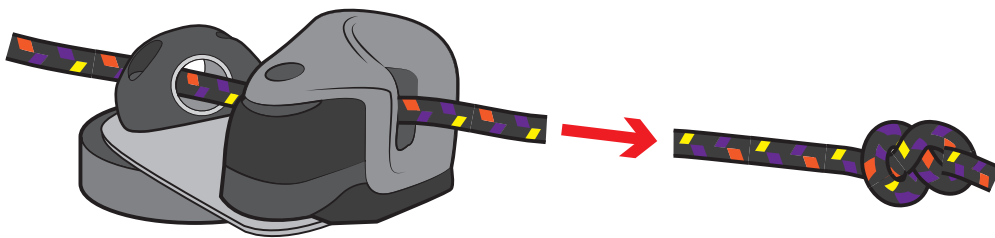

f)

Pull the assembly tight and check that the distance from **block A** to the mast step is 850mm. Adjust as necessary.



- a) Find the trapeze elastic in the rope kit and tie **knot #2** with a 60mm loop in the end and pull tight.

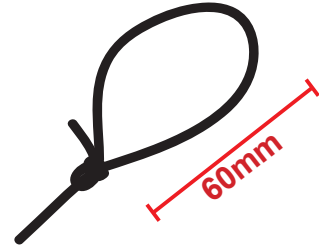

- b) Thread the other end of the elastic as shown.

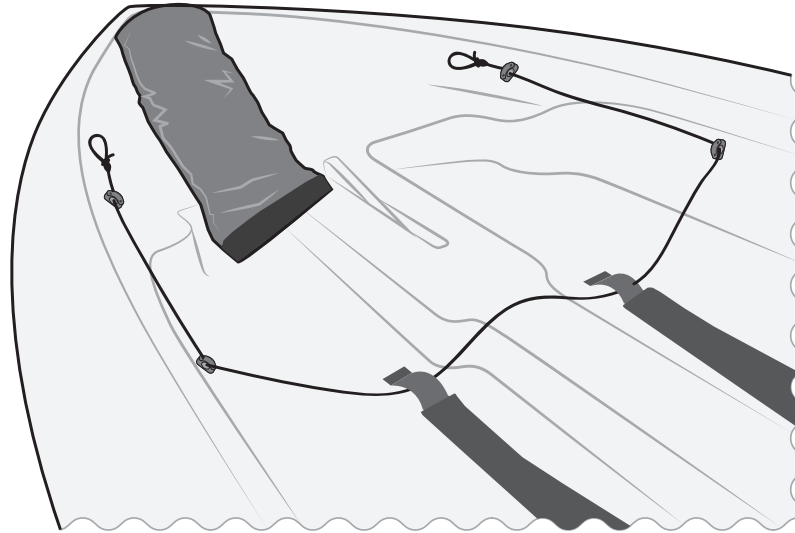

- c) Tie **knot #2** with a 60mm loop in the end.

It does not matter if the bungie is not under tension - i.e. the toestraps rest on the cockpit floor.



- a)

Check the launch line is attached to the spinnaker pole as shown. Re-tie if necessary.

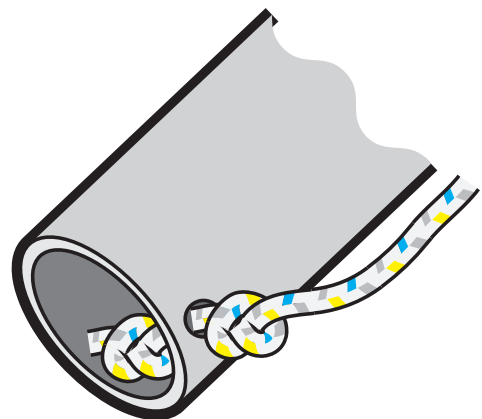

b)

Thread the launch line through the cheek block on the bow.

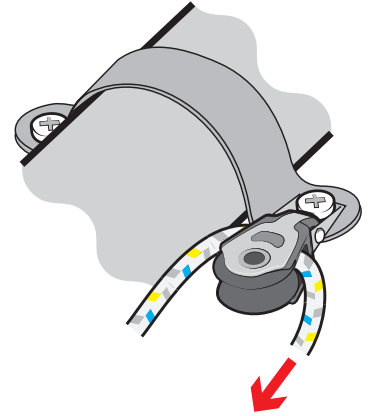

c)

Fully launch the pole so the rope hole in the pole is adjacent to the cheek block.

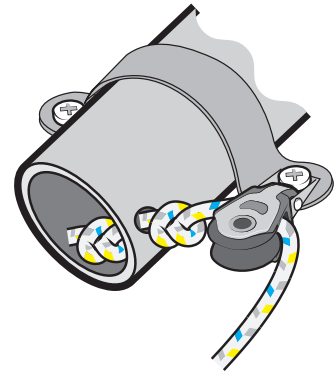

d)

With **knot #1**, tie the block onto the end of the launch line.

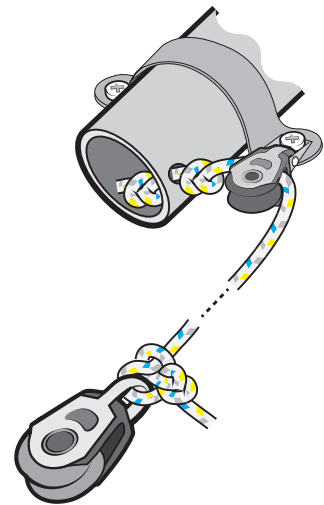

e)

With the block pulled hard towards the mast step the distance between the block and mast step should be 60mm.

Leave a 12mm-15mm tail on the knot.  
Cut and seal excess rope.

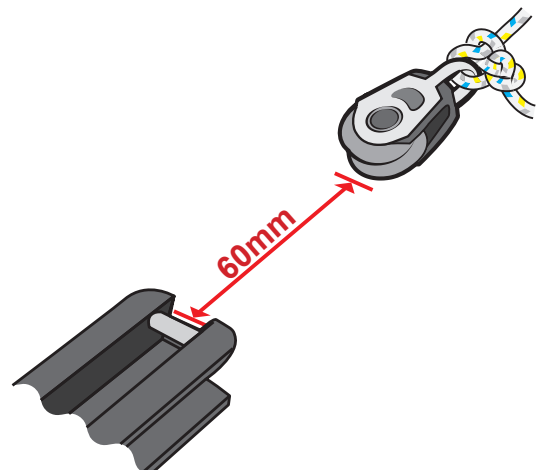

**2.11 - Spinnaker chute elastic**

- a) Find the spinnaker chute **elastic** in the rope kit.



- b) Thread the **elastic** through the spinnaker halyard downhaul block base on the port side.

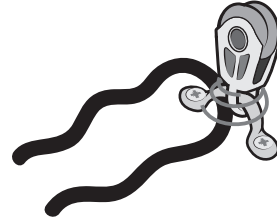

- c) Push both ends of the elastic through the metal cringle on the rear of the spinnaker chute from the inside out.

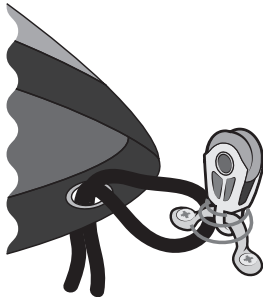

- d) Tie **knot #3** in each end of the elastic.

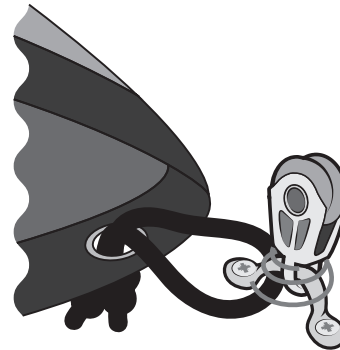

The knots should be under the spinnaker chute not inside.

**2.12 - Spinnaker ratchet elastic**

- a) Locate the two spinnaker ratchet elastics in the rope pack.

- b) Secure one end to the spinnaker ratchet with **knot #1**.

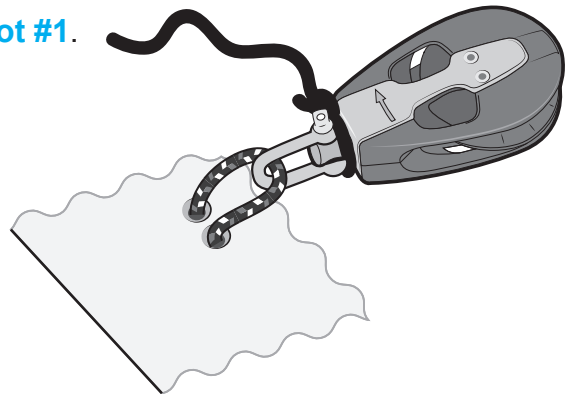

Bungee tail should be 12-15mm.



Make sure the elastic goes between the block and the shackle, not onto the shackle itself.

**RS**  
**500**

## 2.12 - Spinnaker ratchet elastic

- c) Pull the elastic tight and tie the other end the shroud U-bolt using **knot #1**.

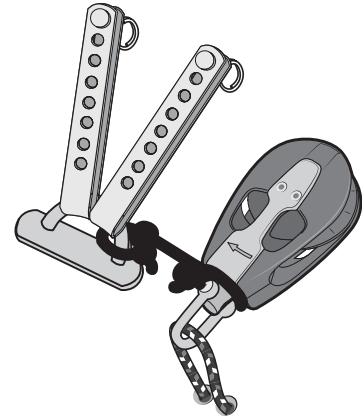

Repeat on the other side of the boat.  
Cut and seal the excess elastic so bungee tail is 12-15mm

**RS**  
**500**

## 2.13 - Centreboard retainer

- a) Find the elastic in the rope pack and the plastic hook from the fittings pack.



- b) Tie a small **#2 knot** in one end and pull tightly. The loop should be approximately 50mm.  
  
Bungee tail should be 12-15mm.

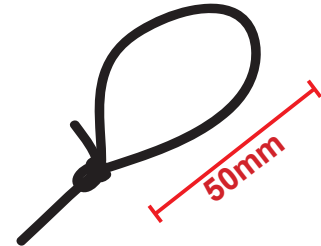

- c) Pass the loop over the mainsheet swivel and make sure it sits between the swivel base and the deck.

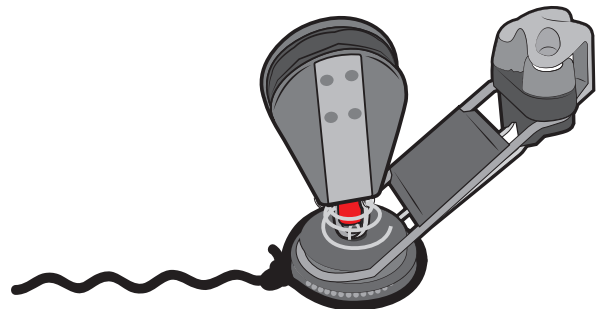

- d) Tie the plastic hook onto the other end using **knot #1**.

Adjust the knot position so the top of the hook just reaches the non skid as shown.

Cut off and seal any excess elastic.  
Bungee tail should be 12-15mm.

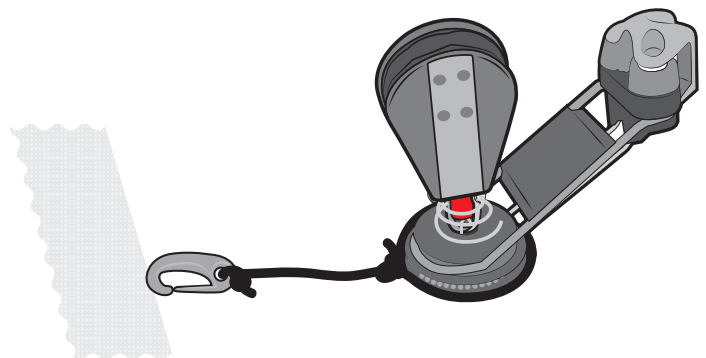

**2.14 - Centreboard handle**

- a) Find the centreboard handle in the rope kit.



- b) Pass one end of the handle through the top hole in the centreboard.

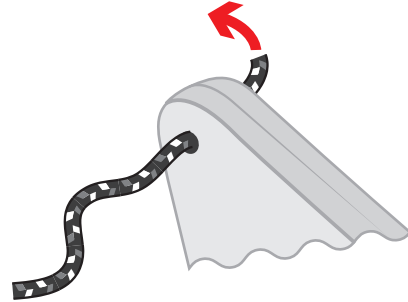

- c) Pull the rope through the board and make the lengths equal.

Place the two ends together, tie **knot #4** in the end.

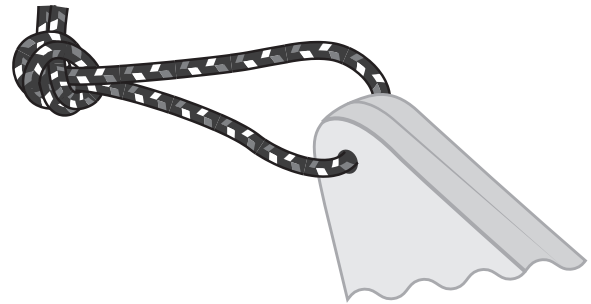
**2.15 - Toe strap tie downs**

- a) Find the two toe strap tie downs in the rope kit.

- b) Tie one end of the rope to the eye on the cockpit floor in front of the toestraps with **knot #1**.

The knot tail should be 12-15 mm

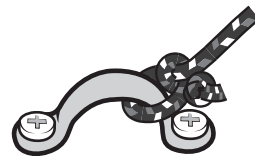

- c) Pass the rope through the toestraps and tie it back onto the eye with another **knot #1**.

The knot tail should be 12-15 mm  
 Repeat on the other side of the boat.

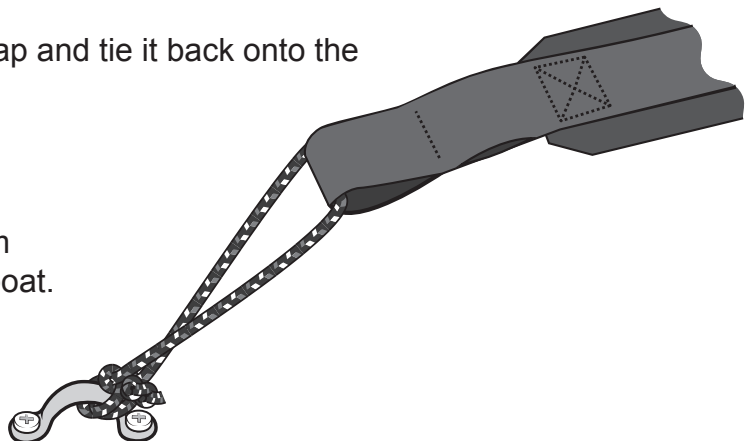

**RS**  
**500**

## 2.16 - Toe strap elastic (rear)

- a) Find the toe elastic in the rope kit



- b)

Thread one end through the second pocket from the aft end of the toestraps.

Thread the other end through the 2nd Toestrap using the same pocket.

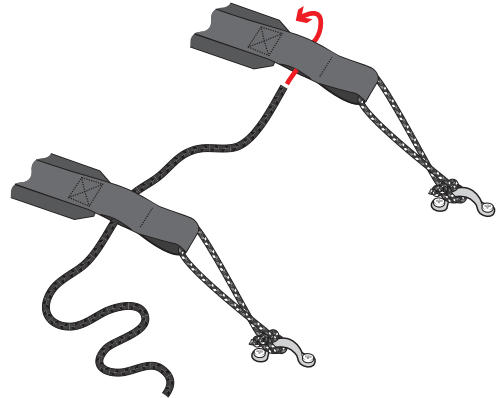

- c)

Tie both ends together with **knot #5**.

Tails should be 12-15 mm.

Hide the knot in the Toestrap pocket.

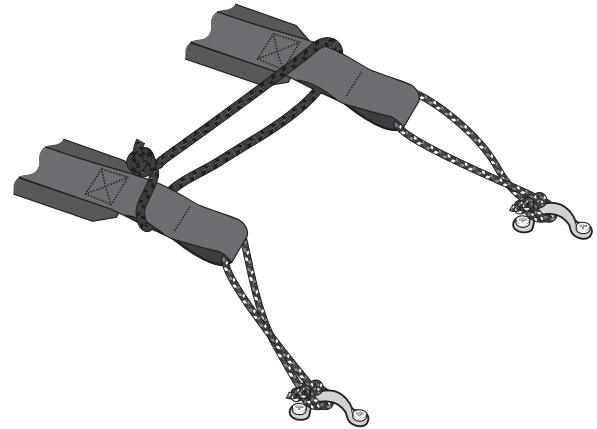

**RS**  
**500**

## 2.17 - Spinnaker halyard take up

- a) Find the spinnaker halyard take up rope and elastic from the rope pack and the 2 spinnaker halyard take up blocks from the fittings pack.

- b)

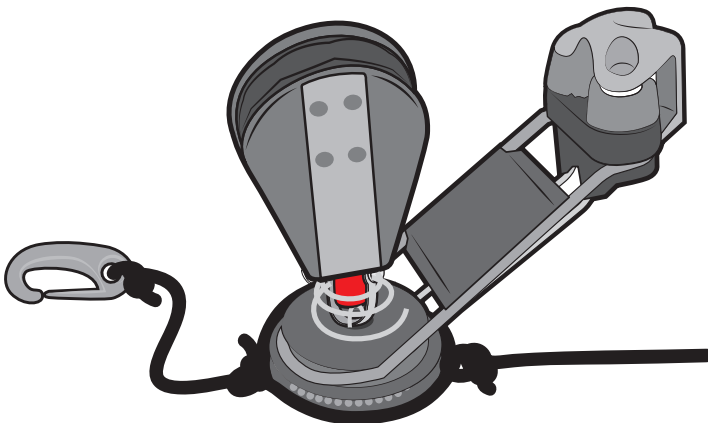

Tie the take up elastic onto the centre board retaining clip elastic at the base of the mainsheet swivel using **knot #1**.

c)

Tie the small block onto the rear toestraps elastic between the two toestraps.

To do this you should tie a **#3 knot** in one end of the short rope. Pass the other end through the eye on the block, around the back of the toe strap elastic and back through the block. Tie another **knot #3**. This puts a stopper knot on each side of the block.

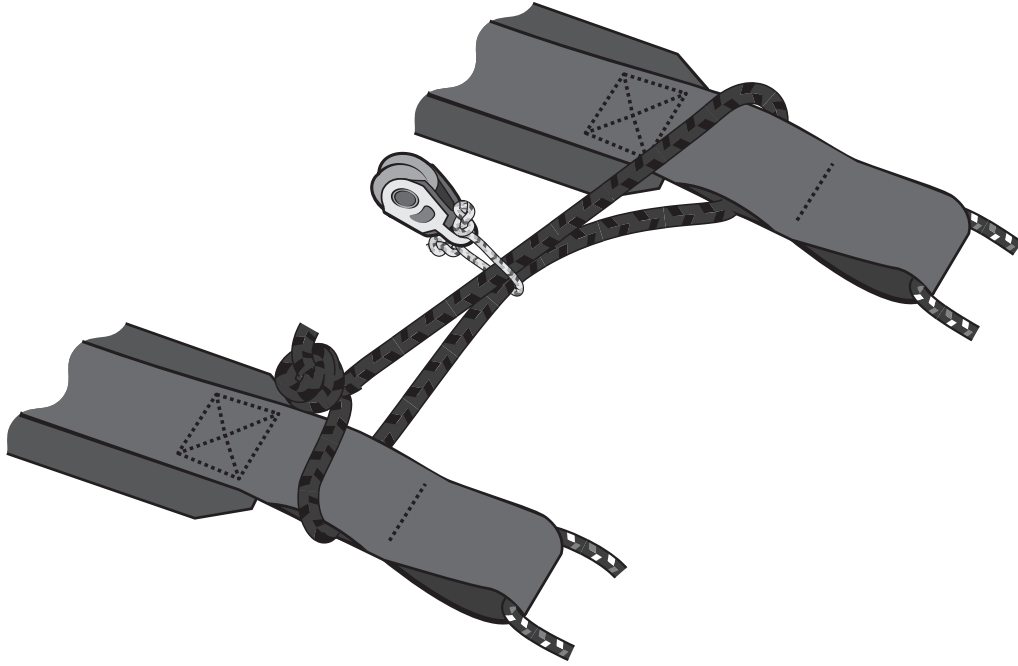

d)

Pass the take up elastic through the small block.

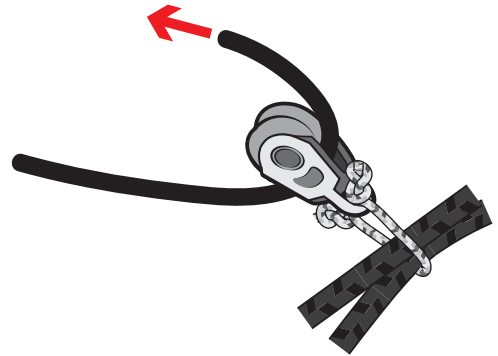

e)

Tie the free end of the elastic to the large block with **knot #1**.

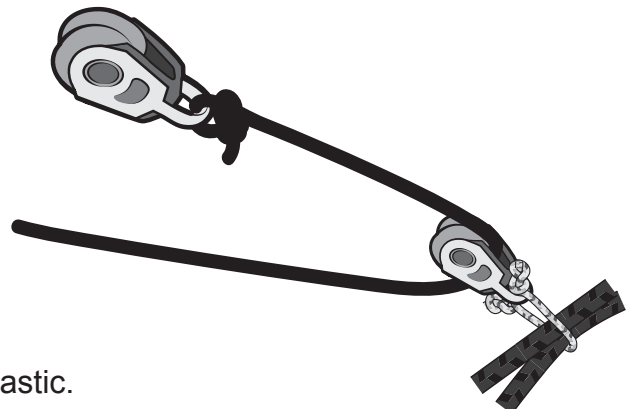

Cut and seal any excess elastic.



**RS**  
**500** 2.18 - Mainsheet rear stop

- a) Find the mainsheet stop in the pack.



- b) Thread one end of the rope through the hole in the gunwale.  
Tie a **#3 knot** under the gunwale.

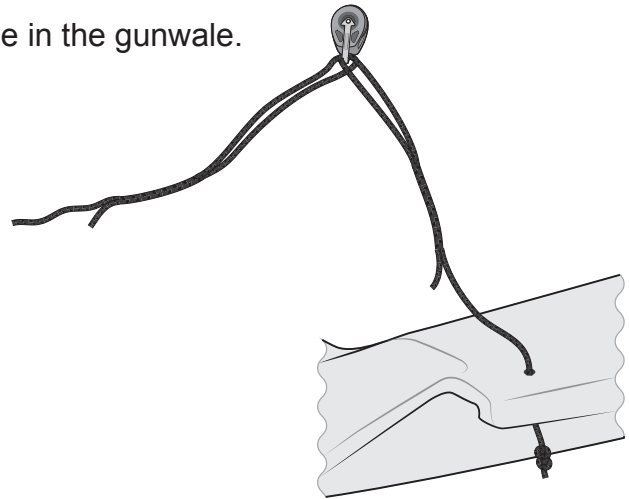

Repeat on the other side of the boat.

**RS**  
**500** 2.19 - Rudder

- a) Locate the two rudder downhaul ropes and the rudder downhaul block in the packs.



rudder downhaul control line

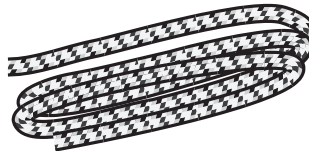

rudder downhaul

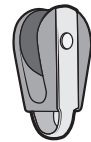

rudder downhaul block

- b) Undo the plastic wing nut on the rudder stock and remove the bolt.

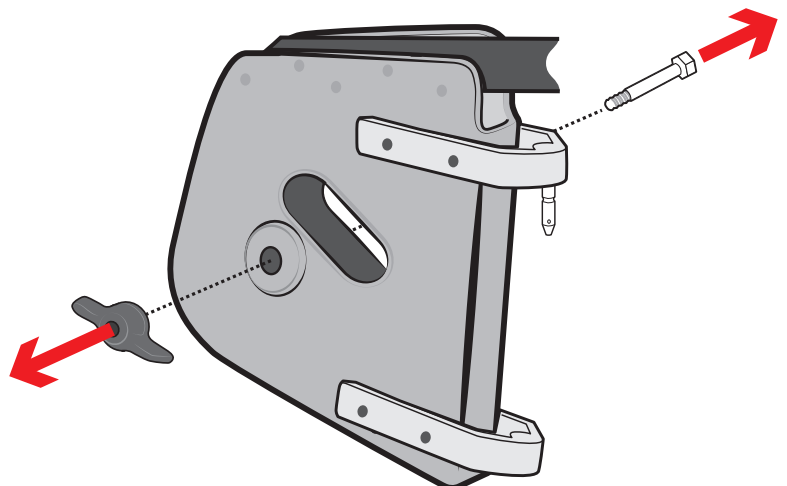

c)

Tie a **#4 knot** in one end of the rudder downhaul rope.

Pass the other end of the rope up through the hole in the front of the rudder.

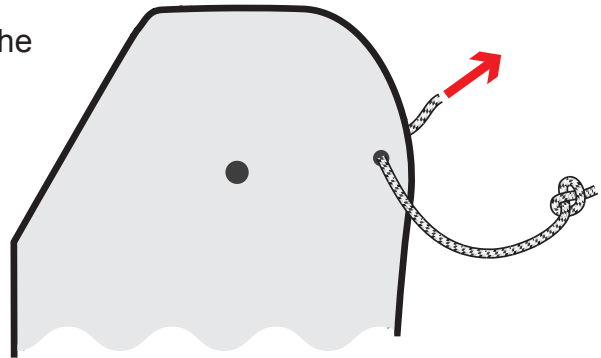

d)

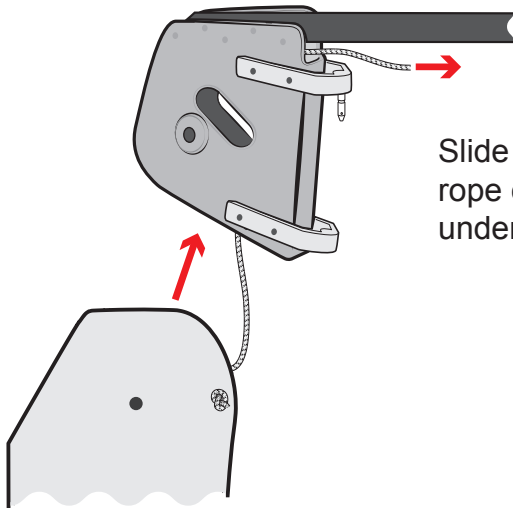

Slide the rudder into the stock making sure to feed the rope over the small roller fitted in the stock, and out under the tiller.

e)

Line up the hole in the rudder with the hole in the rudder stock.

Push the bolt through the stock and rudder, making sure to line up the head of the bolt with the recess in the plastic washer. Also that the little lugs on the plastic washer line up with the holes in the stock. It may need a little tap to get it through!

Refit the plastic wing nut and tighten.

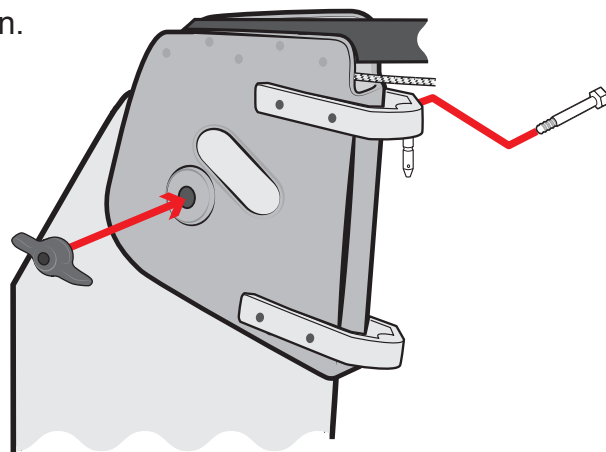

The pivot bolt should be tight enough to hold the blade up under its own weight, but not tight enough as to make it hard to rotate the rudder.

**RS**  
**500** 2.19 - Rudder

f)

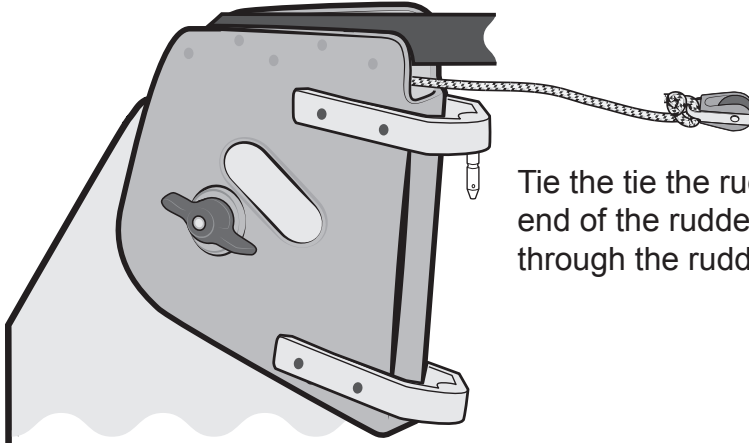

Tie the tie the rudder downhaul block to the end of the rudder downhaul (the rope you fed through the rudder stock) using **knot #1**.

g)

Tie one end of the rudder downhaul control line onto the cleat on the tiller with **knot #2**.

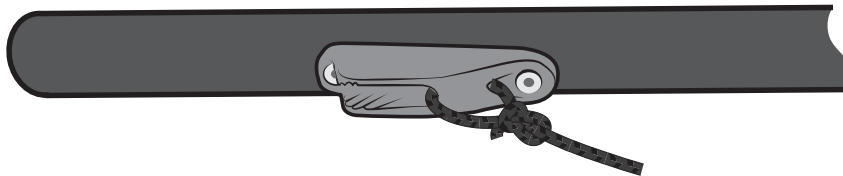

h)

Pass the other end of the control line through the block (added in step f) and back through the cleat on the tiller.

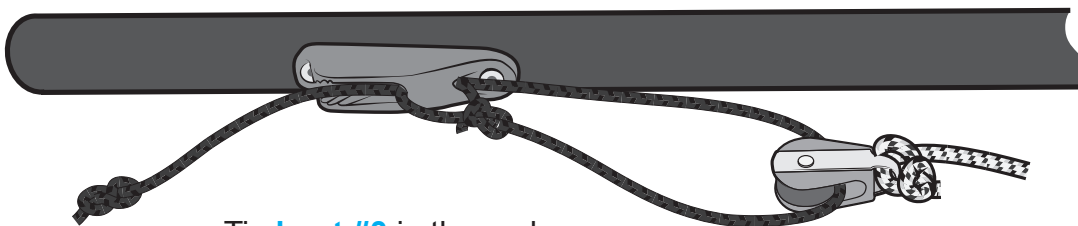

Tie **knot #3** in the end.

# RS 500

## 3. Rigging the mast



PLEASE FOLLOW RIGGING MANUAL IN THE CORRECT ORDER



# RS 500

It is worth taking time over this part to ensure it is correctly completed. Improperly fitted spreaders will result in strange sailing characteristics and may even result in failure of the mast. These settings are a safe starting point. More specific fine tuning is available from the RS class association.

- a) Carefully unpack the spreaders from the top of the mast, being sure not to damage any of the securing split rings.
- b) Unwind the shrouds and forestay from around the mast and unwrap from the packaging.

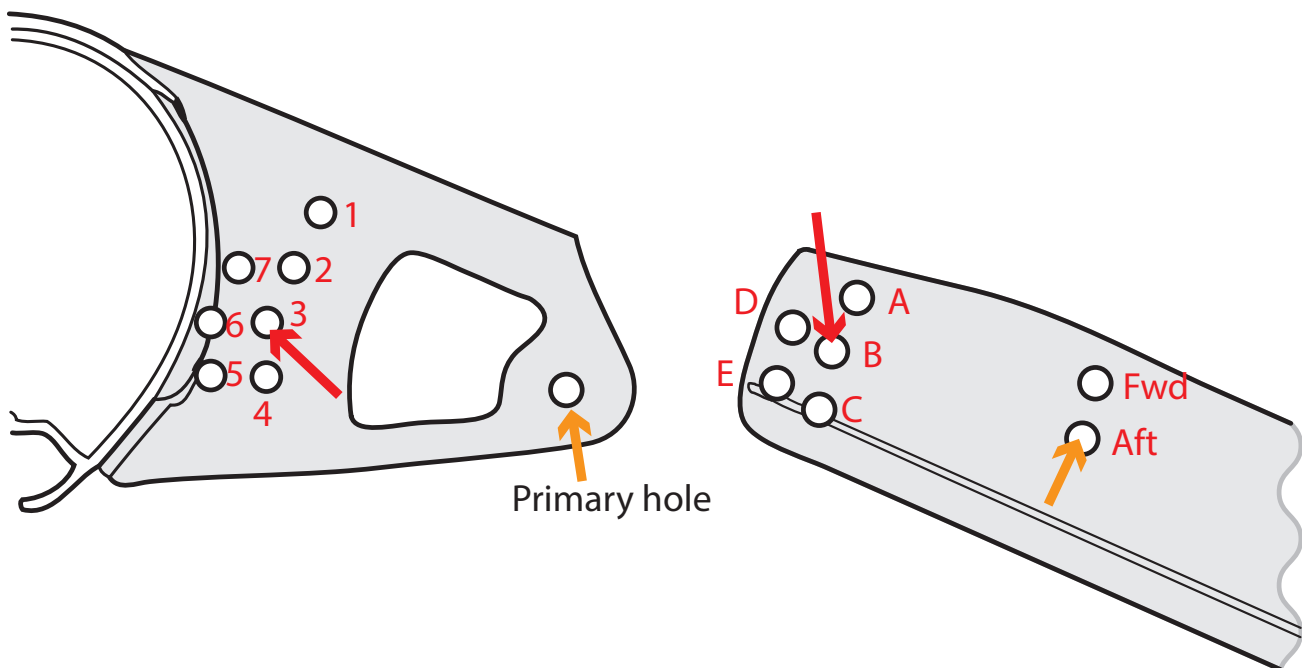

The Primary pin fits through the bracket's **primary hole** and through the **fwd hole** in the spreader.

The Adjuster pin fits down through **hole 3** in the bracket and **hole B** in the spreader.



Tape up all the securing pins and rings to prevent them from being damaged, or from damaging the gennaker or spinnaker.

# RS 500 3.2 - Spreaders

- a) Hook the shroud t-terminal into the lower set of holes near the top of the mast.

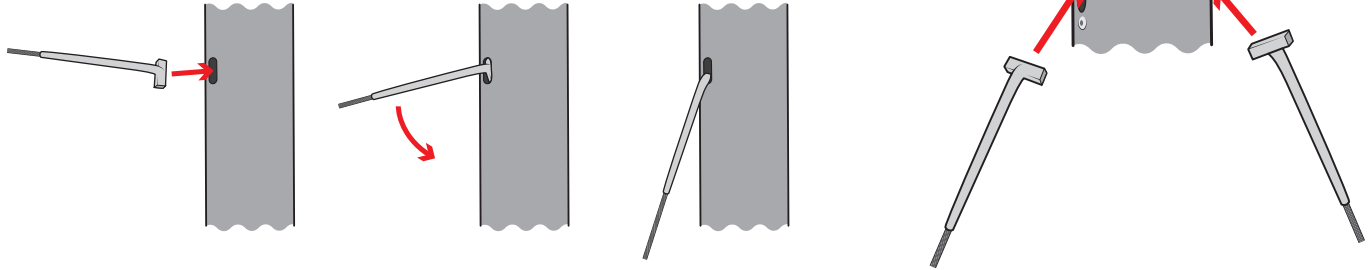

- b)

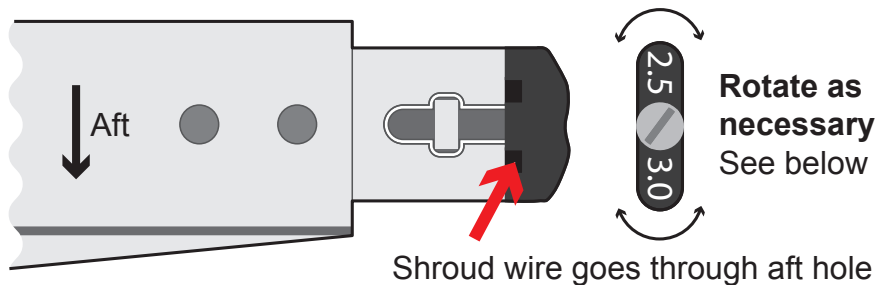

The spreader end cap incorporates two shroud wire slots to give a tight grip on either 2.5 or 3mm wire. The sizes are identified on the front face of the end cap (See diagram above). The RS 500 uses 3mm shroud wire so **the 3mm slot should be used.**

The end cap can also be rotated so that the shroud can be positioned at either the forward or aft position of the spreader end (see diagram above). **For the RS 500 the end cap should hold the shroud in the aft position.**

To attach the shroud, slacken the end screw, rotate the end clamp if necessary, then insert the shroud. Ensure that the shroud is tensioned between T-Terminal and spreader tip, then tighten the screw firmly.

This method “locks in” the dihedral angle.

Length Adjustment:

The position is described by the number of adjustment holes visible. **For the RS 500 there should be 0 holes visible as shown in the diagram above.**



All clevis pins and bolts must be fitted with the flat head on top, and the pins must be locked with a split ring.



Tape all split rings, pins and the outboard end of the spreader extrusion.

This will reduce chafe on the mainsail and prevent flailing sails/halyards becoming damaged. Self-amalgamating tape is best, but pvc electrical tape is an adequate alternative.

a)

Hook the trapeze line t-terminals into the upper set of holes near the top of the mast.

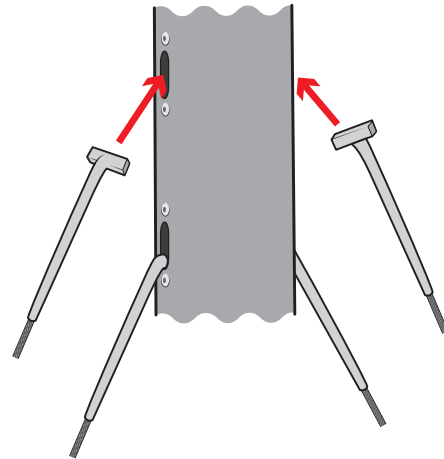
**REMEMBER**

Check that both ends of the main halyard, jib halyard and spinnaker halyard are tied off at the bottom end of the mast so they are within easy reach when the mast is stepped.

Ensure that the forestay is fitted correctly and loose at the lower end.



**BEFORE STEPPING THE MAST, CHECK THAT YOU ARE NOT IN THE VICINITY OF OVERHEAD POWER CABLES**



Before stepping the mast, make yourself familiar with how the “foot” (bottom end) of the mast will fit into the “step” (fitted to the boat).

The mast foot has two rectangular blocks on the bottom, separated by a groove. Both these blocks will fit between the block at the front of the mast step and the bolt in the middle of the step.

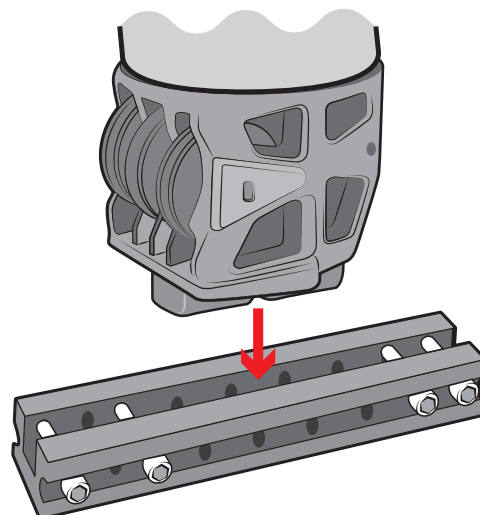

Now the mast is ready to be put up in the boat, or “stepped”.

It is easier to step the mast with two people, however it can be done single-handed. Both methods are shown here.

**RS**  
**500**

### 3.4a - Stepping the mast singlehanded



If the wind is blowing, there will be a lot of pressure on the top of the mast making it wave around. Consider finding somebody to help if you feel you will struggle!

- a) Ensure the mast step area is free from any blocks or rope.
- b) Lay the mast along the boat with the spreader tips just touching the rear cockpit floor and the mast foot alongside the mast step.
- c) Attach the shrouds to the shroud plates (using the upper most hole) and shackle the forestay onto the rear hole of the bow plate.
- d) Step into the boat and step the mast.
- e) Pull the jib halyard tight and cleat whilst standing in the boat.
- f) Step out and attach the forestay and lowers.



Stepping the mast single handed



**RS**  
**500** 3.4b - Stepping the mast with two people

This is a much easier way of stepping the mast, especially if it is windy at all.

- a) Ensure the mast step area is free from any blocks or rope.
- b) Lay the mast along the boat with the foot near the bow.
- c) Attach the shrouds to the shroud plates, using the upper most hole.
- d) Lift the mast out of the boat and stand it up next to the boat.
- e) One person should climb into the boat and stand either side of the mast step, taking care not to stand behind the trolley wheels as the boat will tip up!
- f) The first person should then pass the mast to the person stood in the boat.
- g) The first person then guides the mast step into place
- h) The first person then takes forestay and attaches the rig tension cascade.

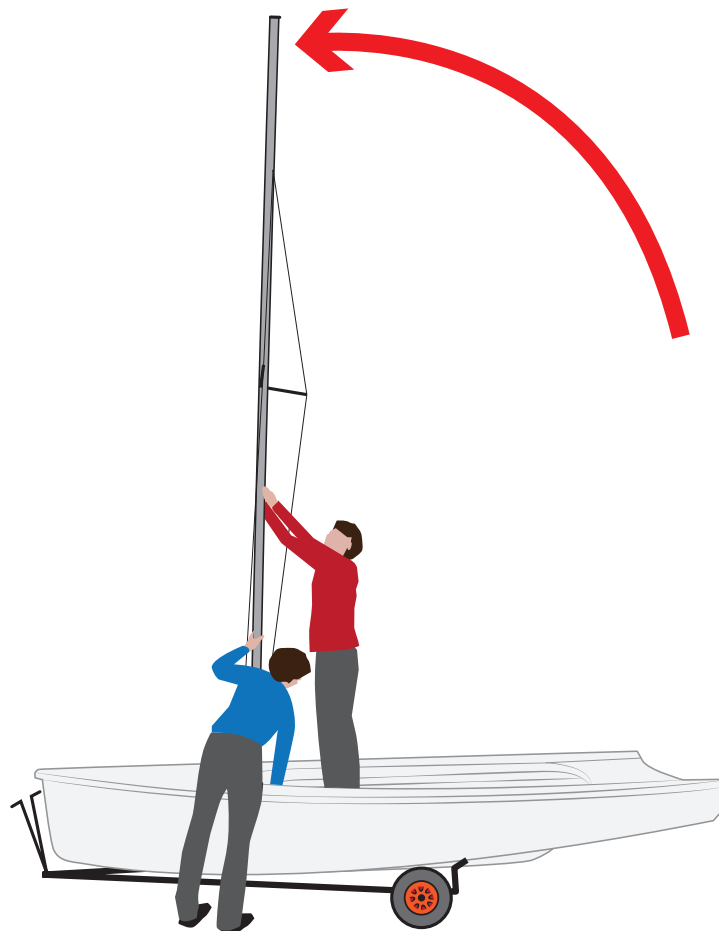

Stepping the mast with two people

### 3.5 - Final rig adjustments

a)

Attach the lower shrouds to the mast.

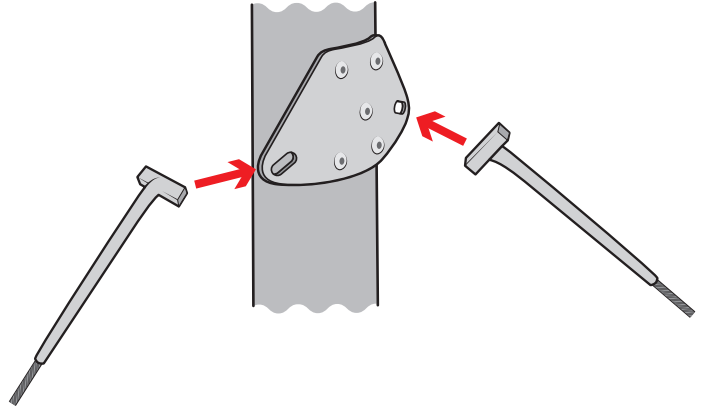

b)

Lower the main shrouds in the shroud adjusters to hole 4, this is a good starting point .

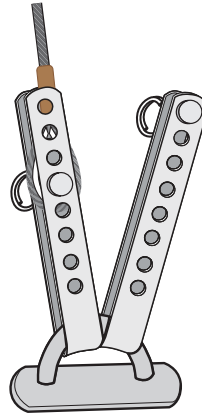

c)

Attach the lower shrouds to the forward set of chain points so they are just slack.

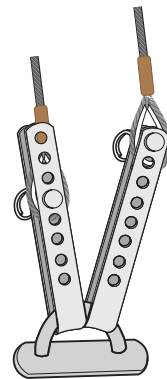

d)

Pull on the rig tension cascade firmly enough so that the rigging is taught. This should make the lower shrouds go tight. If it does not then you will need to let the rig tension off, adjust the lower shroud position and try again.



**3.6 - Rigging the spinnaker halyard**

When the spinnaker halyard it is pulled it will hoist the spinnaker but also pull the bowsprit out too. This achieved by the spinnaker halyard running through a block tied to the bowsprit launch line.

- a) Under the spinnaker sock at the bow you will find the bowsprit outhaul line and block. Pull on this block and you will see the bowsprit pull out to its sailing position.

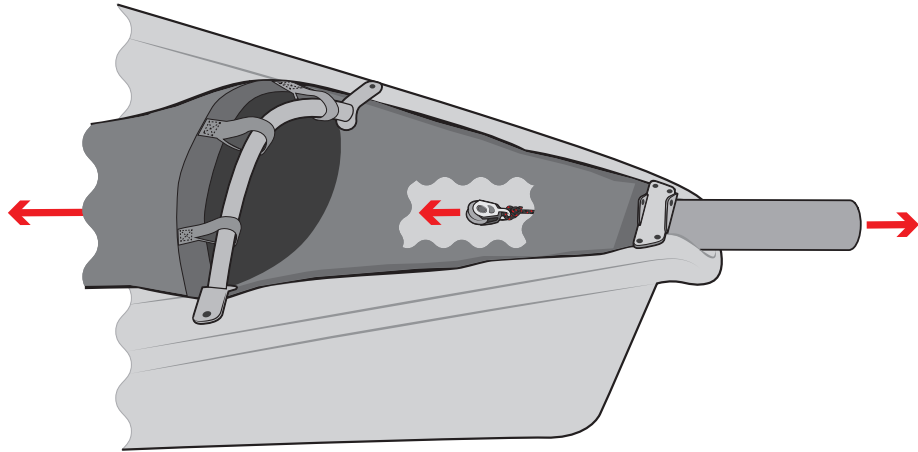

- b) Take the loose end of the spinnaker halyard, from the block at the base of the mast, forward through the bowsprit outhaul block and then back to the spinnaker halyard cleat.

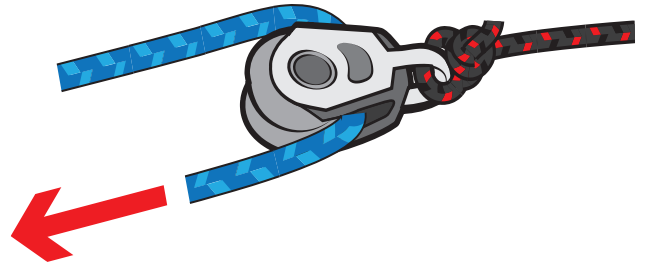

- c) Thread the end of the halyard through the cleat and through the hoist block.

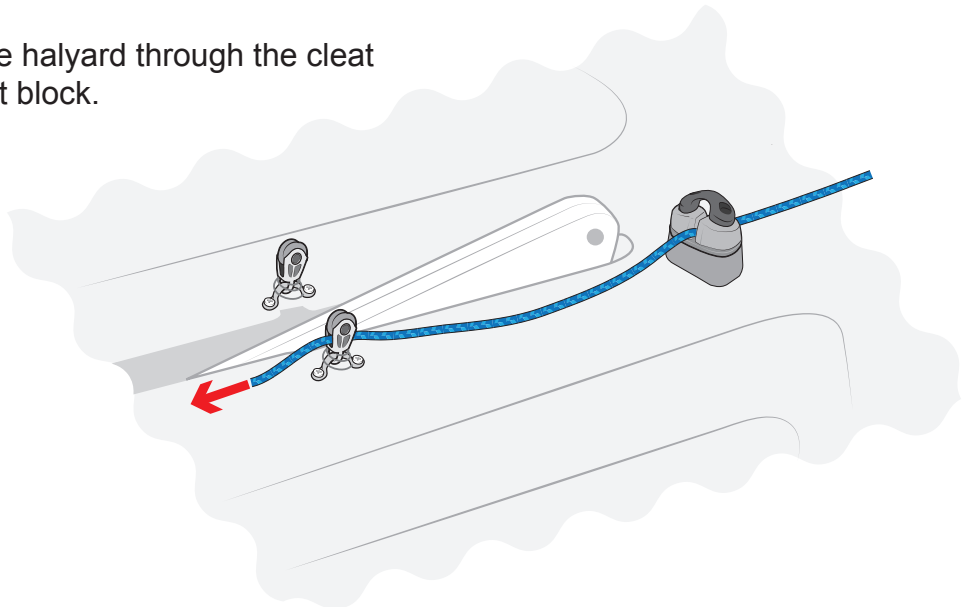

## 3.6 - Rigging the spinnaker halyard

d)

The halyard then runs over the top of the centreboard, through the take-up block (added in **section 2.14e**) and through the spinnaker drop block on the other side of the centreboard case, this time being threaded through from back to front so the tail will then go up the spinnaker chute.

Once the spinnaker halyard has been passed up the inside of the chute, tie the tail off on the chute mouth bar for safe keeping until the

Both sides of the spinnaker halyard should pass on the same side of the mainsheet base - i.e. don't let the mainsheet base sit in the middle of the spinnaker halyard as it travels to the transom then forward to the spinnaker chute.

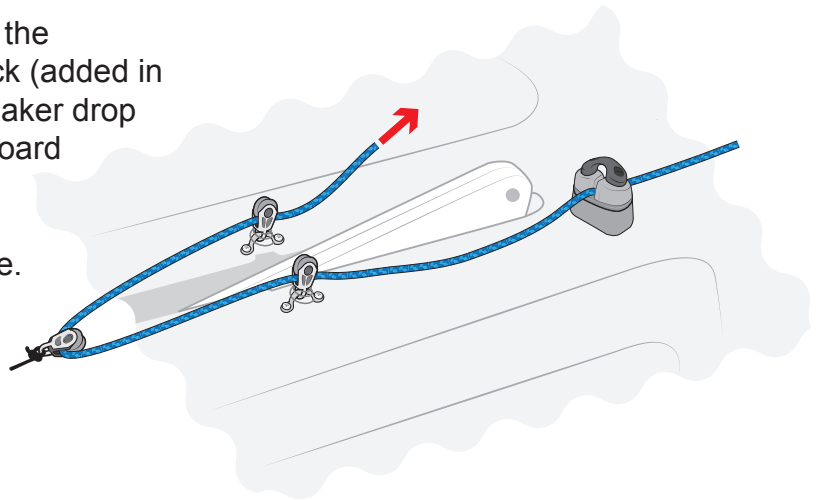

## 3.7 - Rigging the boom

To complete this section you will need:

- The boom
- The gnav

a)

Connect the gnav bar to the slider at the front end of the boom.

Note: the slider fitted may look different to the picture but it still works in the same way.

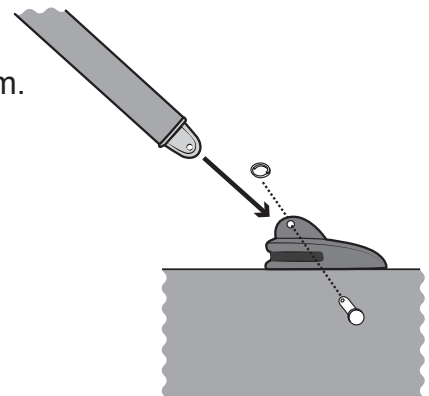

b) Open the drop nose pin then connect the front of the boom to the gooseneck on the mast.

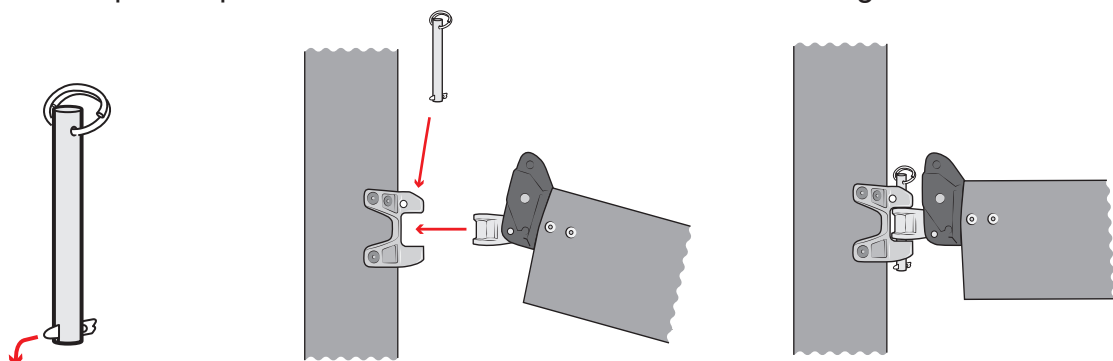

## 3.7 - Rigging the boom

- c) Connect the upper end of the gnav bar to the bracket on the mast above the gooseneck.

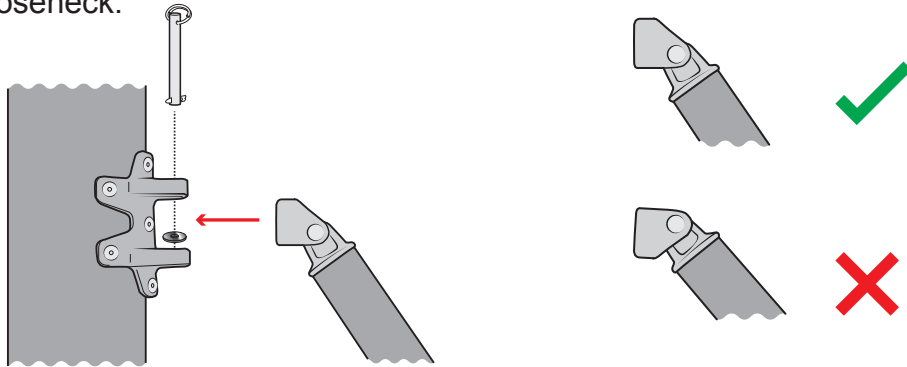

It is vital that the gnav toggle is inserted as shown above. Failure to do so will result in damage to the strut assembly.

- d)

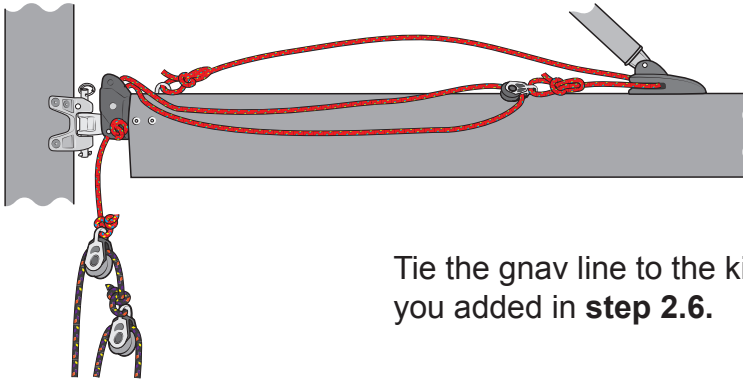

Tie the gnav line to the kicker cascade in the boat which you added in **step 2.6**.

## 3.8 - Rigging the jib

To complete this section, you will require:

- The jib.
- The jib sheets.

- a)

Unroll the jib and connect the tack (lower forward corner) to the bow fitting using the tack tie provided.

The height of the jib away from the bow is a tuning item and is covered more in **section 5 'sailing hints'**.

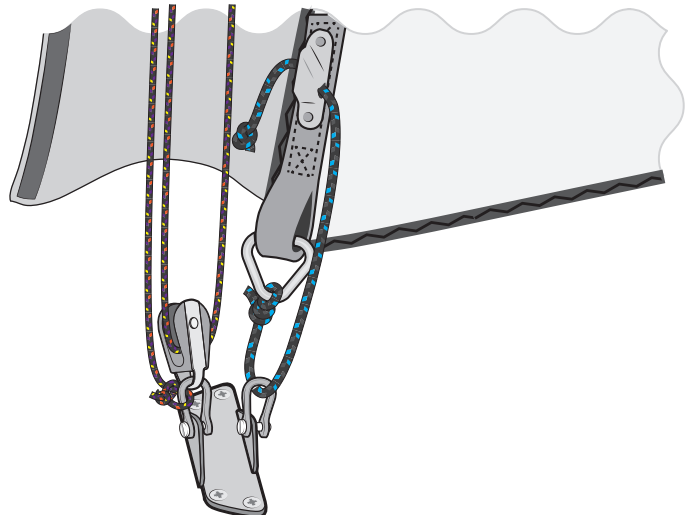

b)

Attach the head of the jib to the jib halyard.

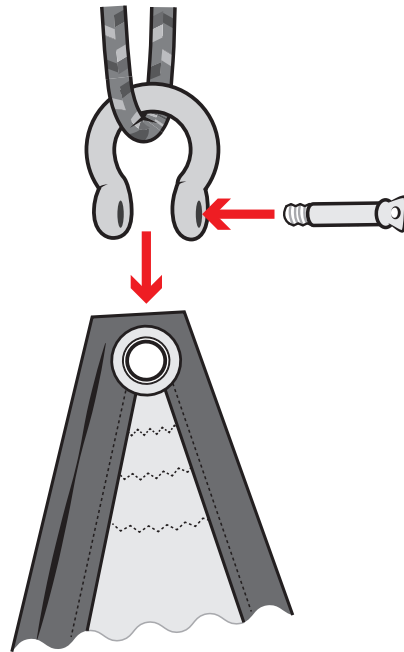

c)

At the base of the mast, pull the jib up using the halyard. When the halyard is pulled all the way up, cleat it in the cleat just above the mast foot.

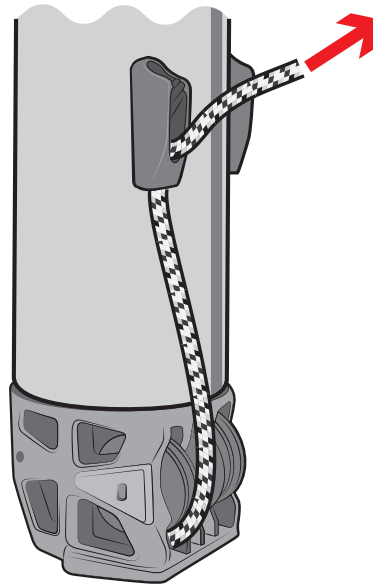

d)

Take the 2x 30mm ball bearing blocks and the jib sheet block tie from the pack.

Tie the two blocks together through the cringle at the clew of the jib using **knot #1**.



## 3.8 - Rigging the jib

e)

Tie **knot #3** in one end of the jib sheet and pass it through the p-clip located between the jib fairlead and jib cleat.

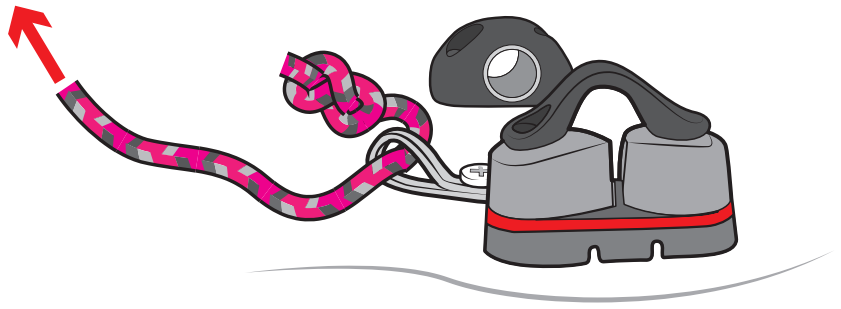

f)

Pass the other end through the clew of the jib and back through the fairlead and jib cleat.

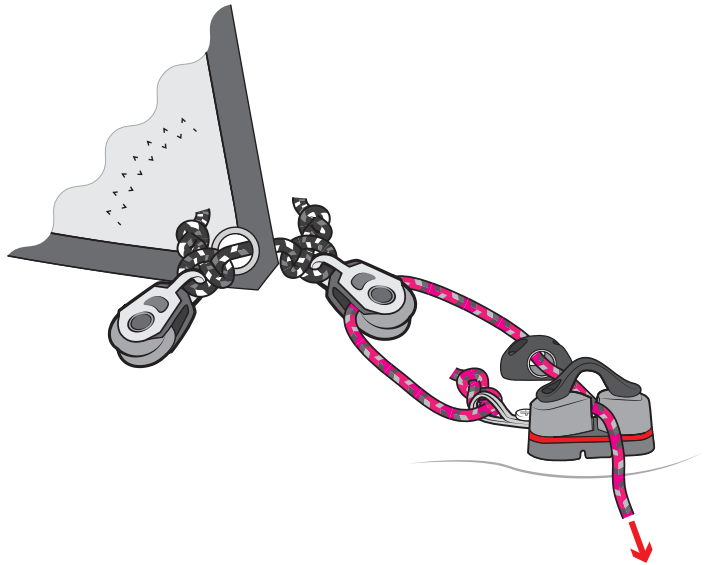

g)

Pass the jib sheet across the boat.

Repeat **steps e-f** but in reverse this time, so going through the jib cleat first.

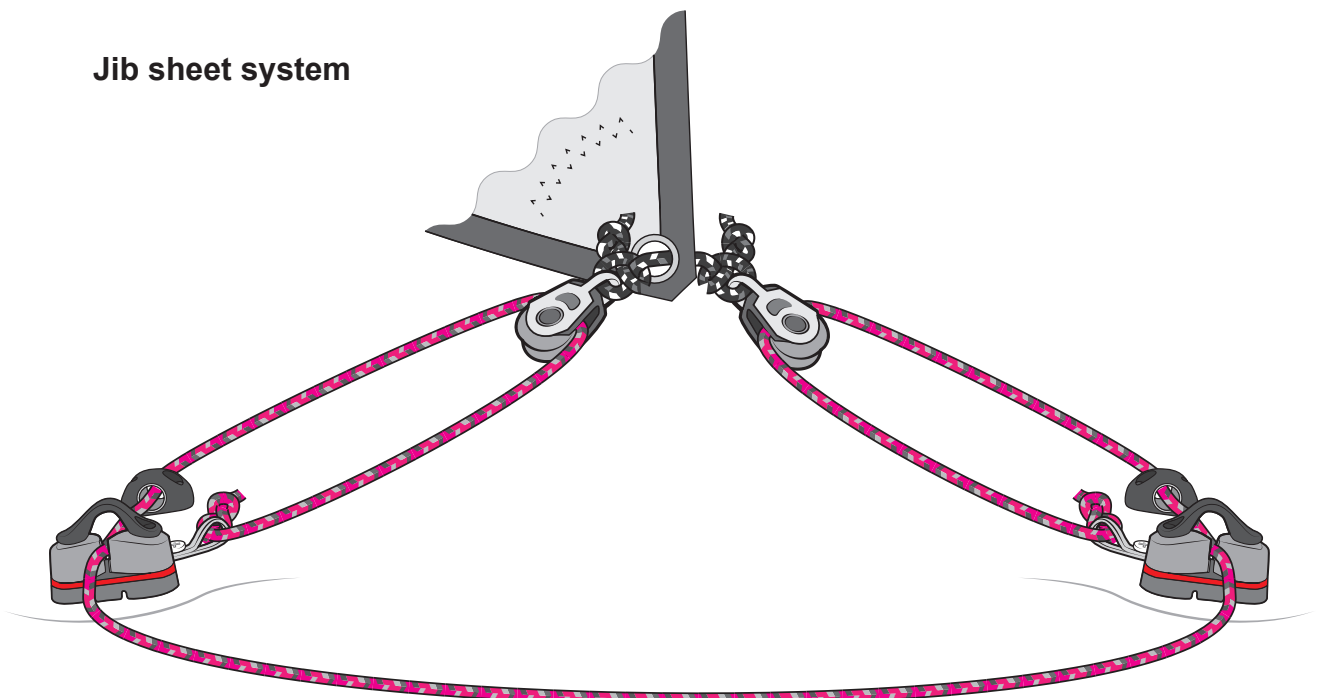
**Jib sheet system**

## 3.9 - Rigging the mainsheet

To complete this section, you will need:

- The mainsail (either S or XL).
- The mainsheet.

a)

Tie **knot #4** in one end of the mainsheet and pass it through the middle of the block at the end of the boom.

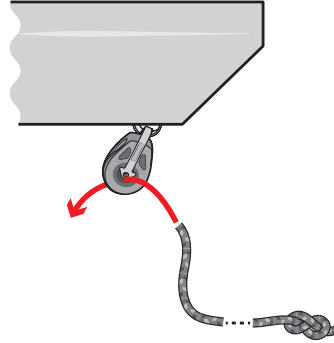

b)

Take the other end of the mainsheet through the block on the rear mainsheet strop (which you added in **step 2.15**) passing from front to back.

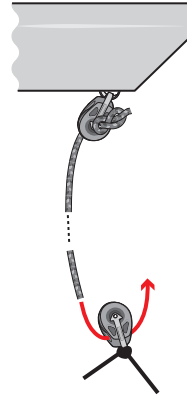

c)

Run the mainsheet back up through the block at the end of the boom, passing from back to front.

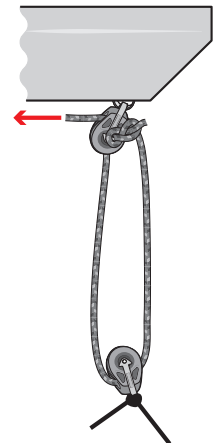

d)

Run the mainsheet along the under side of the boom, ensuring it is passed through the webbing loops (these stop the mainsheet hanging down when it is slack).

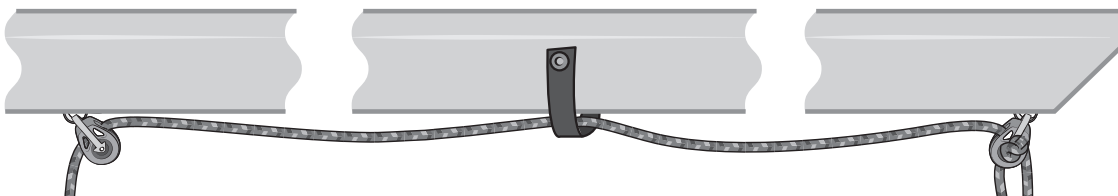



## 3.9 - Rigging the mainsheet

e)

Finally, thread the mainsheet through the centre ratchet block (the block is an automatic ratchet block so pull on both ends of the rope to engage it and check you have threaded it the correct way, using the arrow for guidance) and then through the mainsheet cleat.

Tie a **#3 knot** in the end.

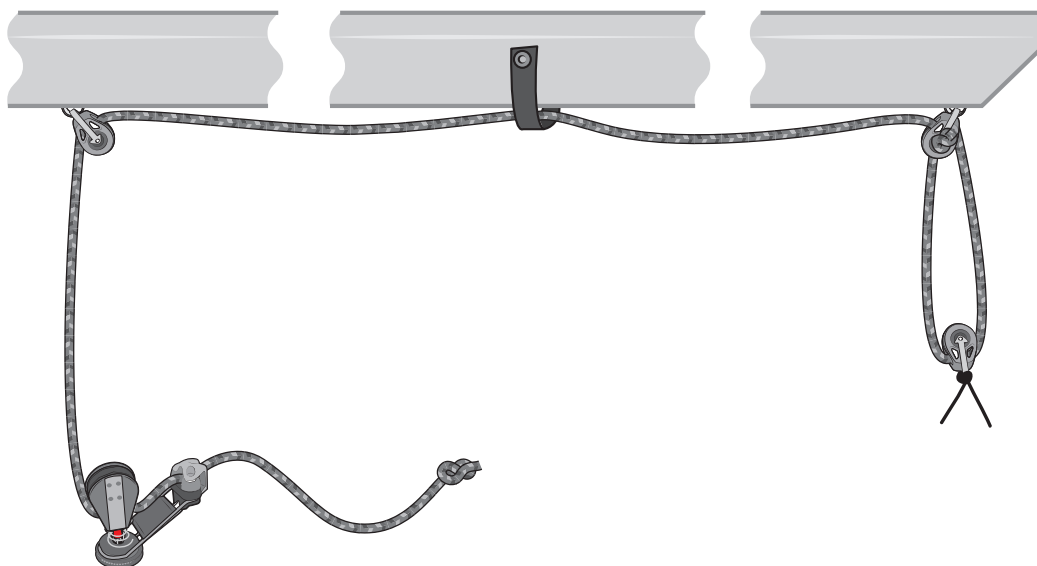

## 3.10 - Hoisting the mainsail

To hoist the mainsail:



Put the boat head to wind.

a) Unroll the mainsail.

b) Take the end of the main halyard that emerges from the top of the mast, and tie it to the head of the mainsail, using a knot-on-knot.

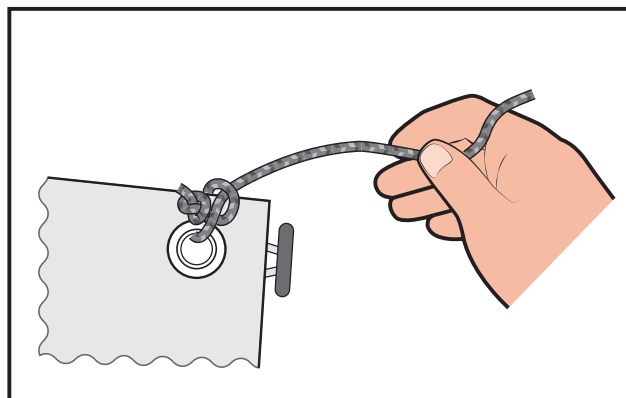
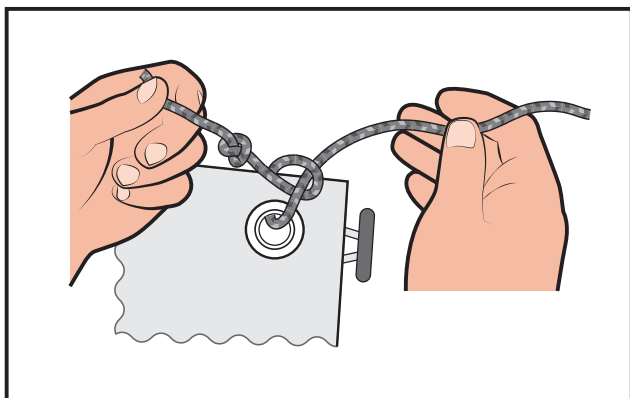

## 3.10 - Hoisting the mainsail

c)

Put the top of the main sail into the opening in the mast track, just above the gooseneck mast collar, from the starboard side of the boat.

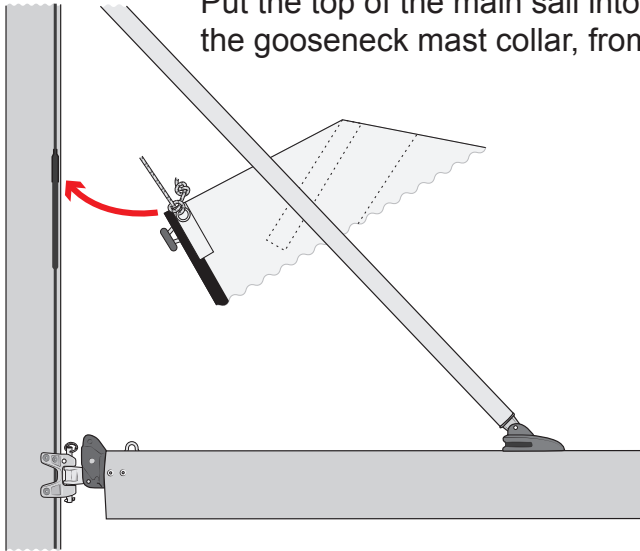

d)

Holding the main sail in line with the mast, pull on the end of the main halyard.

Pull the main sail up to the top of the mast. You will need to keep the sail in line with the mast to make pulling it up easier, especially when passing the batten pockets.

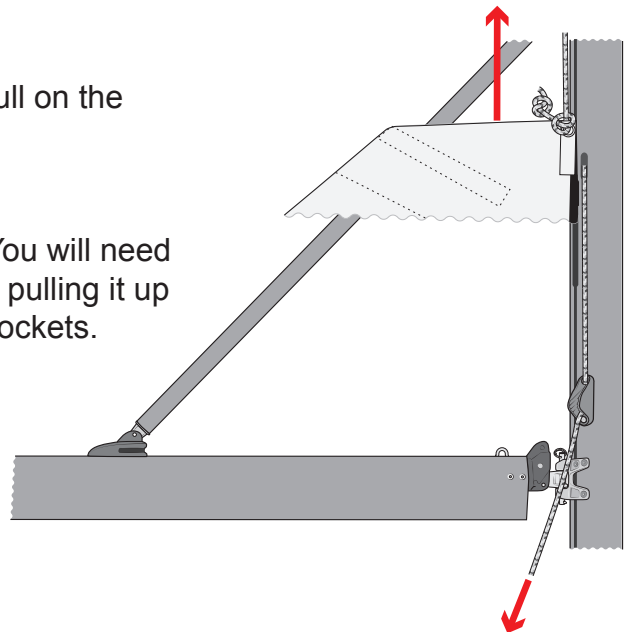

e)

When the main sail is almost at the top of the mast, slide the mainsail clew slug into the track on the top of the boom.

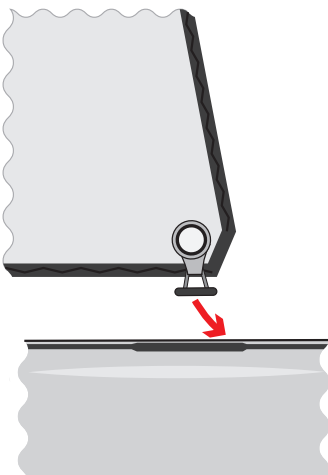

## 3.10 - Hoisting the mainsail

- f) Pass the end of the outhaul rope through the clew of the main sail and clip it on the end of the boom. Ensure that the main halyard rope is in the cleat and pull the main sail to the top. Pull on the main sail at the bottom corner near the mast to check that it is properly cleated.

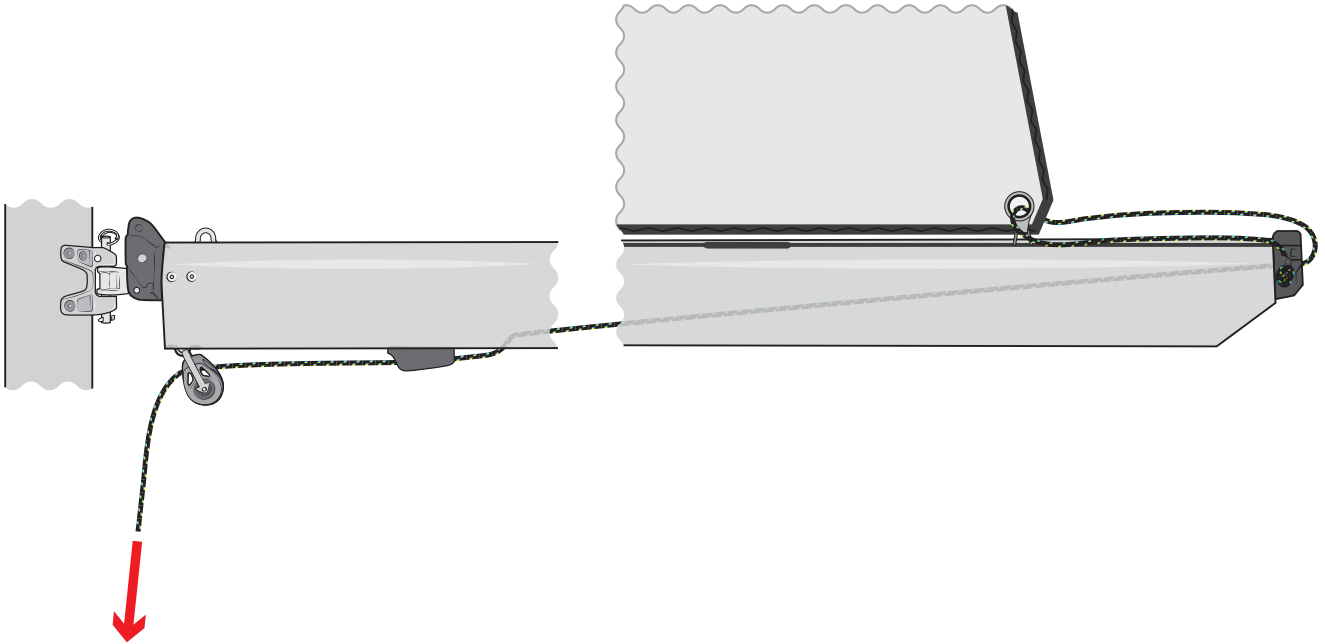

- g) Insert the slug on the tack of the mainsail into the track on the mast and pull the tack of the sail down towards the boom.

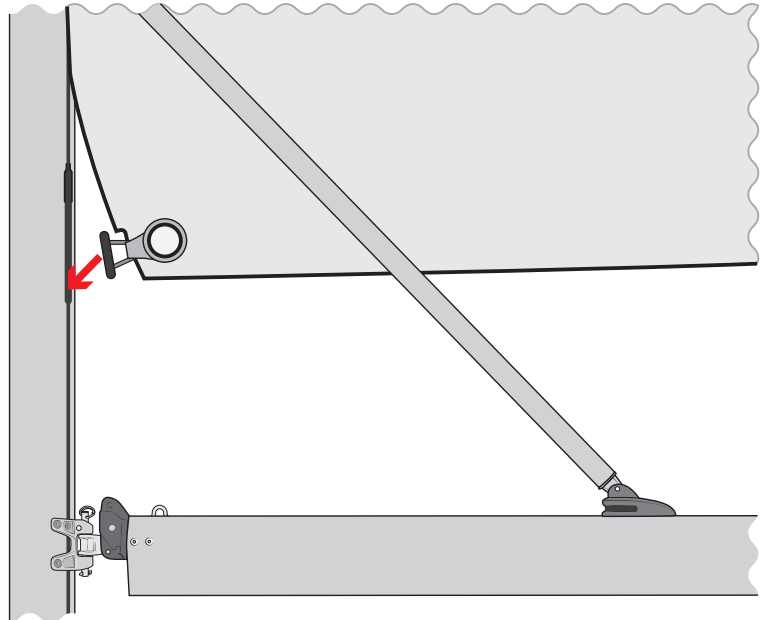

- h) Tidy the main halyard and stow it in the bag under the spinnaker sock.

## 3.11 - Mainsail tack strap

a)

This strap helps to keep the tack of the mainsail in place.

Put the strap through the tack eye of the mainsail, then strap it onto the mast.

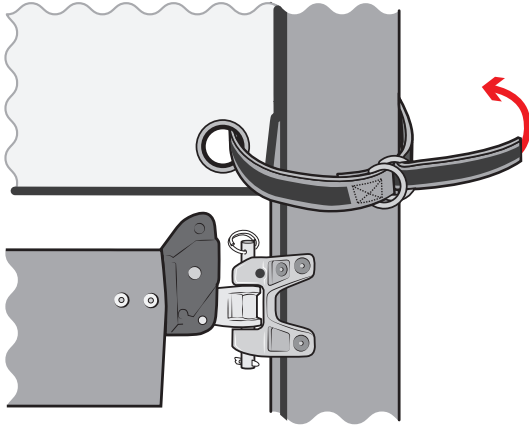

Make sure the main halyard goes under the strap to prevent it from uncleating the halyard.



The spinnaker and jib halyard need to go over the strap to minimise friction.

## 3.12 - Downhaul

a) The downhaul is already tied to the mast, so all you need to do is pass the end of the rope through the bottom eyelet in the mainsail and then down through the cleat on the back of the mast.

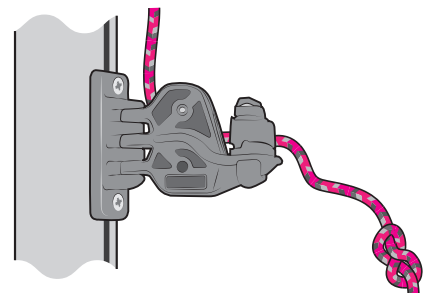
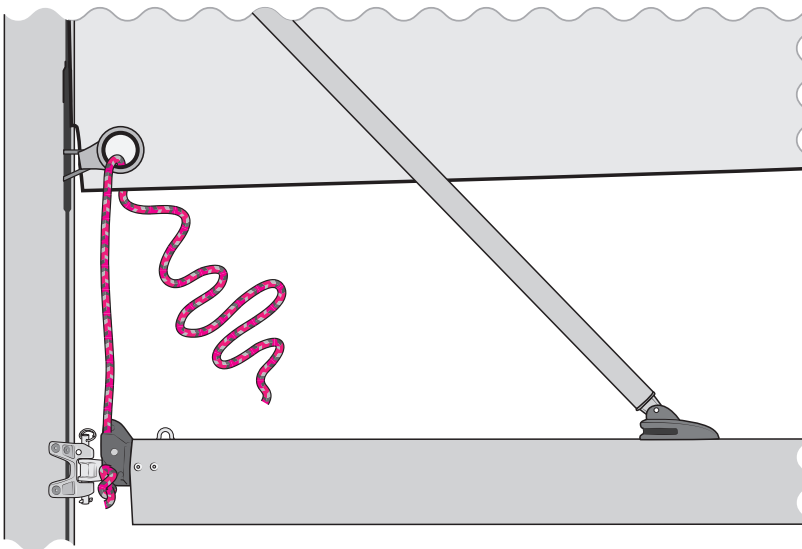

### 3.13 - Rigging the spinnaker

To complete this section, you will need:

- 1 x RS 500 spinnaker.
- 1 x spinnaker sheet.

a) Unpack the spinnaker.

b)

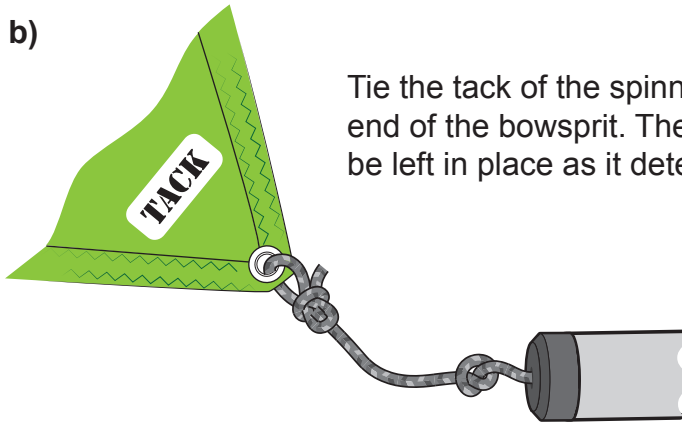

Tie the tack of the spinnaker to the 'tack line' that emerges from the end of the bowsprit. The knot that is already in the tack line needs to be left in place as it determines how far the bowsprit comes out.

c)

Tie the end of the halyard to the head of the sail with **knot #2**.



d)

Take the spinnaker downhaul line (the other end of the halyard), which is rigged up the chute and with the spinnaker on the starboard (right) side of the boat pass the end through the ring on the sail from bottom of sail to top of sail direction.

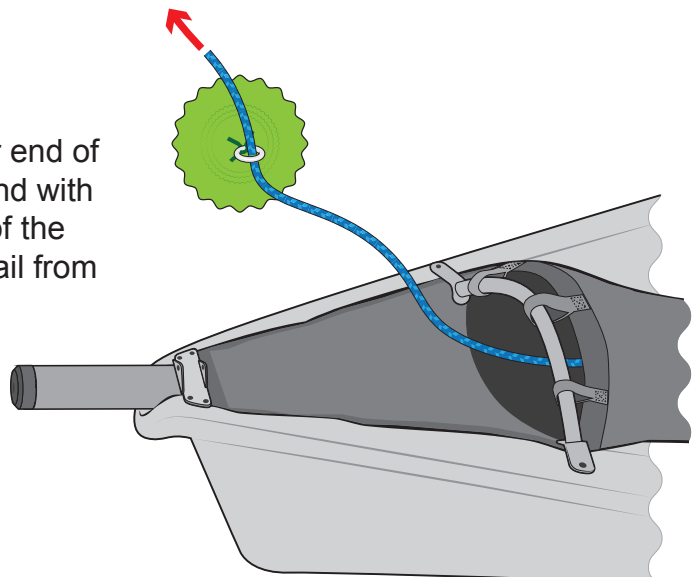

3.13 - Rigging the spinnaker

e)

Run the downhaul up the sail and pass the end through the ring in middle of the sail from bottom of sail towards the top of the sail.

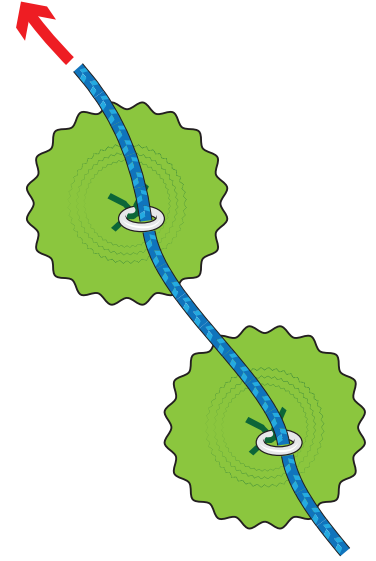

f)



Run the downhaul line up the sail and tie it off on the upper patch (onto the cross of webbing) with **knot #2**.

Note:  
Adding a **knot #3** or small bobble 15cm from the patch will improve spinnaker downhaul performance.

g)

Find the middle of the spinnaker sheet and double it over to form a loop.

Pass this loop through the eyelet at the clew of the sail.

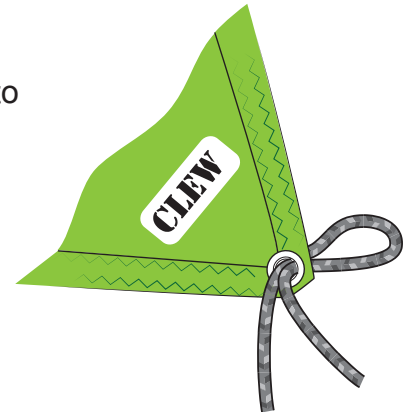

h)

Pass the rest of the sheet through the loop and pull it tight to form **knot #6**.

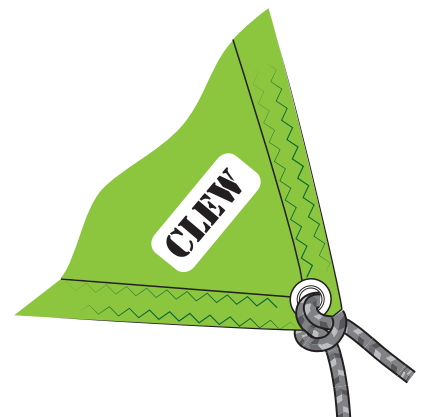

## 3.13 - Rigging the spinnaker

i)

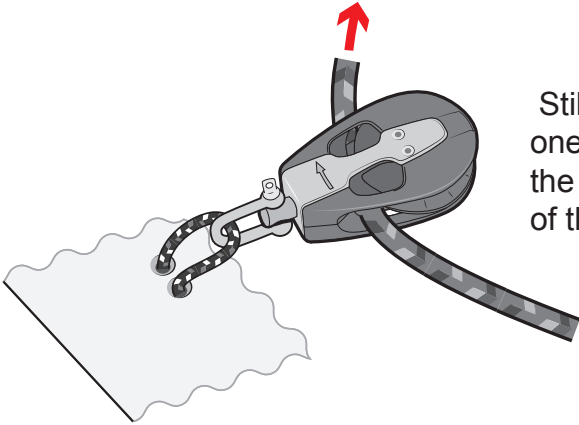

Still with the spinnaker on the starboard side, thread one end of the spinnaker sheet through the block by the shroud point on the starboard side, in the direction of the arrow.

i)

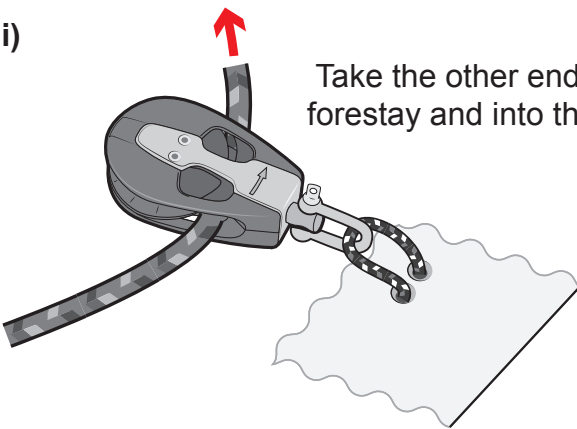

Take the other end of the spinnaker sheet and pass it around the forestay and into the block on the other side. Tie the two ends together.

j)

Pull the spinnaker from one side to the other, as if you were gybing, to see if anything is twisted.

Finally, pull the spinnaker downhaul to pull the spinnaker down into the chute.

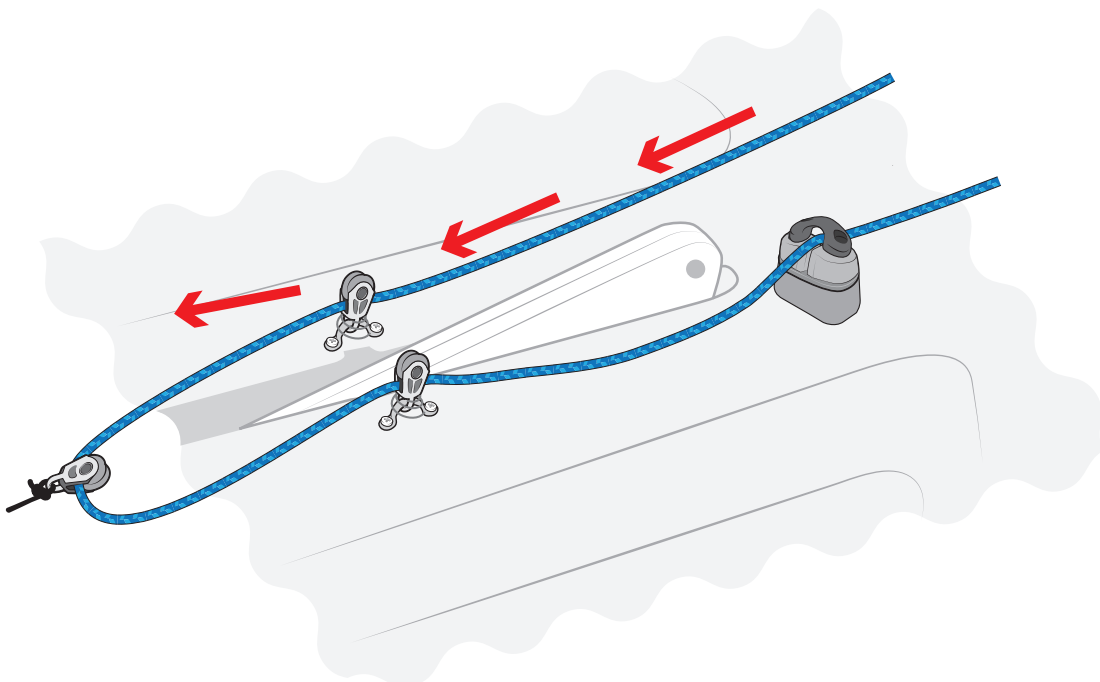

# RS 500

## 4. Completion



PLEASE FOLLOW RIGGING MANUAL IN THE CORRECT ORDER



# RS 500



Now you are almost ready to go 500 sailing. All that is left to do is:

- Fit the rudder to the back of the boat.
- Tidy the halyards away.

- a) To fit the rudder, simply line up the pins with the fitting on the back of the boat and push down until the retaining clip 'clicks' into place.



The rudder may be difficult to get on at first but all it will need is a simple waggle from side to side whilst pushing down.

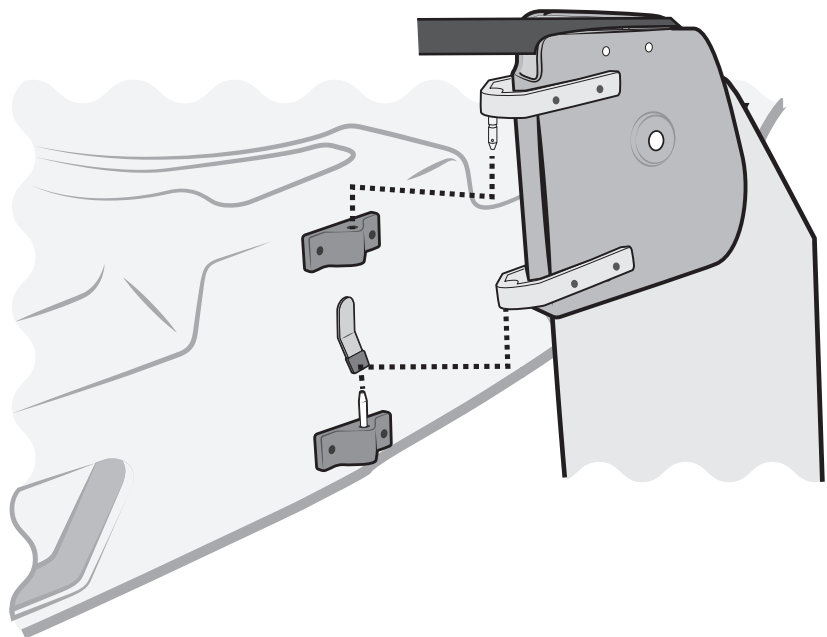

To remove the rudder, simply push the retaining clip in and pull up on the stock.

- b) Coil the main and jib halyards neatly and stow them in the Velcro pocket fitted on the underside of the spinnaker sock.

**Now you are ready to go sailing in your RS 500!**

# RS 500

## 5. Sailing Hints



PLEASE FOLLOW RIGGING MANUAL IN THE CORRECT ORDER



# RS 500

# RS 500

## 5.1 - Introduction

The RS 500 is a very rewarding boat to sail – to fully appreciate its handling, you should be comfortable with the basic techniques of sailing small boats. If you lack confidence or feel that a refresher is in order, there are many approved sailing schools which can offer refresher courses in trapeze and asymmetric technique.

See [www.rya.org.uk](http://www.rya.org.uk) for more information.

While we offer you a few hints to aid your enjoyment of your new boat, they should not be considered as a substitute for an approved course in dinghy sailing. In order to build your confidence and familiarise yourself with your new boat, we recommend that you choose a fairly quiet day with a steady wind for your first outing.

# RS 500

## 5.2 - Launching

With the sails fully hoisted, and the rudder attached, the boat should be wheeled into the water, keeping it head to wind as far as possible. If you have a crew, s/he can hold the boat head to wind whilst the trolley is stowed ashore.

### TOP TIP

If the tide is coming in as you launch, make sure that you leave the trolley far enough up the beach that it will not be swept away.

# RS 500

## 5.3 - Leaving the beach

The easiest way to get going is for the helm to step aboard while the crew holds the boat. The helm should put a little centreboard down, then move back to his normal position and lower some of the rudder blade. Then, s/he may instruct the crew to push the bow off the wind and climb in. The crew will then lower the centreboard as depth allows. As soon as the water is deep enough, the centreboard should be fully lowered, and the retaining elastic clipped to the rope handle to prevent it retracting into the hull in the event of a full inversion.

### TOP TIP

If you are using the jib, pulling this sail in as you leave the beach will ensure that the bow continues to swing away from the direction that the wind is blowing from.

As soon the water is deep enough, make sure that you lower the rudder blade fully. You will know it is fully down if you feel a gentle “thud” as the front face of the blade hits the front face of the stock. Push the tiller down to lock the blade. Pull the sail in and you are away! For the best performance, you should ensure that you and your crew position yourselves so that the boat is sailing through the water as upright as possible.

### TOP TIP

As a general rule, sit further forward in lighter winds and further aft in stronger breezes.

## 5.4 - Sailing Close-Hauled and Tacking

When sailing close-hauled, or as close as possible to the wind, it is important to get the boom as near as possible to the centreline, especially when sailing the with the mainsail and jib. The kicking strap should be firmly tensioned for upwind work.

The jib sheet should be pulled in fairly hard when sailing upwind – tighter in stronger winds and less so in lighter winds. Sail to the jib tell-tails, keeping the one on the back of the sail streaming and the one closest to you either streaming or lifting upwards slightly.

To tack, push the tiller extension away from you and, as the boat starts to turn, step across the cockpit facing forwards. Once the boat has completed the turn, bring the tiller back into the centre before sitting down on the new side, with the tiller extension behind your back. When you are settled, swap the mainsheet and the tiller extension into the new hands.

If the boat slows right down and feels lifeless when close-hauled, you could be sailing too close to the wind. Ease the mainsheet and 'bear off' ie. turn away from the wind for a while to get the boat going again.

## 5.5 - Sailing Downwind and Gybing

When sailing downwind, both sails should be let out as far as possible. To gybe, pull the tiller towards you and, as the boat starts to turn, step across the cockpit facing forward. Once the boat has completed the turn, bring the tiller back into the centre before sitting down on the new side, with the tiller extension behind your back. Often, the boom will not want to come across until you have nearly completed the gybe, so it often pays to give the mainsheet a tweak to encourage the boom over at the moment that you want it to come! Don't forget to duck your head as the boom comes over. Once you are settled, swap the mainsheet and the tiller extension into the new hands.

## 5.6 - Using the Gennaker

If you are inexperienced in using a gennaker, choose a fairly quiet day for you first excursion. A gennaker nearly doubles your sail area, and should be treated with a healthy degree of respect!

For your first hoist you should be sailing downwind on a broad reach, with the wind on your quarter. Your crew should stand astride the centre capping, and hoist the spinnaker from the right hand halyard block.

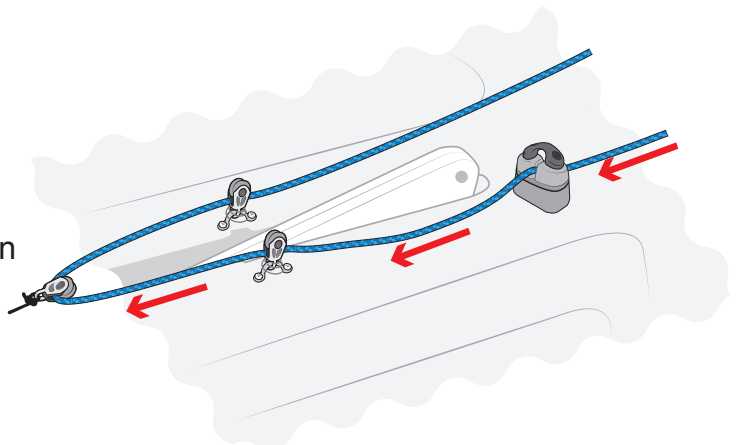

The halyard pulls the pole out at the same time, and so as the halyard comes to a stop when hoisted all is ready to go. The crew should now pull gently on the sheet, whilst the boat is luffed up gently and the spinnaker will soon fill.

Spinnakers may be effectively used from a close reach to a broad reach, and thus to get downwind one should become adept at gybing. Tacking is not possible with the kite set. For best affect the sheet should always be eased as far as possible, so that the luff is just on the point of curling.

Gybing with the spinnaker is fairly straightforward: Think of it exactly as a big jib, and it should be pulled across as the main comes across. Pull across as soon as possible as delay or allowing the kite to flog may result in an “hourglass” effect. As soon as it has been pulled in and filled with wind it should again be immediately eased for maximum efficiency and speed.

Dropping the spinnaker is the reverse of the hoist: The boat should be borne off to a broad reach, and the slack in the downhaul, pulled in from the left hand halyard block, taken up. As it goes tight the halyard should be popped out of the cleat and the spinnaker then pulled sharply into the chute. Dropping the spinnaker on tighter reaches is harder, requiring more effort on the downhaul (the end of the halyard that pulls the spinnaker down).

#### **HINT**

The spinnaker can “bunch up” when entering the chute, and this can be minimised by keeping some restriction on the sheet and thus stopping the clew getting sucked in with the main body of the spinnaker.

When the spinnaker is fully lowered it is always worth tidying the sheets and halyard to keep the cockpit area sorted.

# RS 500

## 6. Maintenance



PLEASE FOLLOW RIGGING MANUAL IN THE CORRECT ORDER



# RS 500

The RS 500 is made of FRP (fibre reinforced plastic), a fibre glass cloth and polyester resin. This is stiff and light, but will dent if subjected to point loading. The boat should be supported ashore on a recognised RS trolley, as the hull may distort if not supported properly.

Obviously in dealing with a marine environment, equipment gets wet, which in itself is not a problem. The problem starts when moisture is trapped for any length of time. The key, therefore, is to store the boat properly ashore.

Keep your dinghy drained and well ventilated.

All composite structures, no matter what they are made from absorb moisture which increases weight and under additional circumstances causes cosmetic blistering and raised fibre pattern. Obviously in dealing with a marine environment, equipment gets wet which in itself is not a problem. The problem starts when moisture is trapped for any length of time - e.g. a dinghy is left with a PVC cover on for several weeks, the cover fills with water and pulls the cover tight over the foredeck and sidedecks, the moisture trapped between the cover and the deck alters in salinity and creates the start of an osmotic cell.

To help avoid this situation:

- a) Ensure the boat is kept at an angle that allows water to run off the cover and internal water to drain out of tanks.
- b) If using a PVC cover, make sure it is removed and the boat well ventilated at least once a week. Better still, get a breathable cover - polycotton, acrylic or cotton duck.
- c) When using an undercover, make sure the cover has an opening in the bottom to prevent water draining from the cockpit and filling the undercover. Do not leave the under cover on for long periods.

### **Wash with fresh water.**

Fresh water evaporates far quicker than salt water, so if your dinghy has been sailed in salt water, don't stop at the sails, fittings and external surfaces, wash the tanks out as well. This is not as daft as it sounds - all RS tanks are vented and sooner or later water will enter, particularly after prolonged capsizes. When this happens, drain the tanks and lightly spray a fresh water hose pipe into the tank to lift off the salt water and then the tank will have a much better chance of drying out.

**6.1 - Hull care**

Hull damage falls into three categories:

- **SERIOUS** – large hole, split, crack or worse. Don't be too distressed! Get the remnants back to RS Racing – most problems can be repaired.
- **MEDIUM** – small hole or split. If this occurs during an event, sailing can often be continued as long as leaking can be prevented by drying the area and applying strong adhesive tape. **CAUTION** – if the damage is close to a heavily loaded point then a close examination should be made to ensure the surrounding area will accept the loads. Get the damage professionally repaired as soon as possible.
- **SMALL** – chip, scratching. This type of damage is obviously not life threatening but needs to be attended to, firstly to keep the boat looking good and secondly to prevent water ingress into the laminate. This type of damage can be rectified by you the owner, if you wish. Buy the correct colour gel coat repair kit from your RS dealer and either wait for a dry warm day outside or preferably put your boat in a dry warm place under cover.

**6.2 - Foil care**

The foils are FRP with a foam core. Look after them as you do the hull. Wash with fresh water regularly. Repair any chips as soon as possible.

If you intend to travel a lot with the boat, then an RS padded rudder bag would be a worthwhile investment.

**6.3 - Spar care**

The mast, boom and bowsprit are aluminium. Wash with fresh water as often as possible, both inside and out. Check all the riveted fittings on a regular basis for any signs of corrosion or wear.



Good racing sails today are expensive items, yet it is surprising how many people are prepared to neglect or mistreat them. The rules for correct sail care are easy and simple to implement.

- a)** The jib and mainsail should be stored dry, out of direct sunlight when not in use (ultra-violet light damages sailcloth), and rolled:
  - Ensure there are no folds in the cloth as you roll the sail.
  - If you do have a fold or crease, unroll the sail and let the crease drop out. DO NOT PULL IT OUT!! This action can tear sailcloth.
- b)** Asymmetric spinnakers should be stored dry and loose if possible, do not leave them in the chute with the corners hanging out! Do not dry spinnakers by allowing them to flap in the wind.
- c)** When using brand new sails for the first time, try to ensure that the conditions are not too extreme because the high loads on new sailcloth can diminish the racing life of the sail. This particularly applies to the Hard Dacron jib, which may get a lot of those 'Little white score marks'. Do not allow sails to flap unnecessarily. Where possible, take sails down between races and as soon as possible after sailing.
- d)** If your sail is stained in any way, try to remove it using normal detergent and warm water. Do not attempt to launder the sail yourself.
- e)** Repairs should be temporarily fixed using sticky number cloth or sail repair tape and then returned to a sail maker for a professional repair.
- f)** Check the batten tension regularly, slack battens can work their way out of the luff retaining caps and damage the sailcloth. The battens should be tensioned enough in the pockets so that when the boat is sailing there are no wrinkles in the batten pockets. Watch out for wear and tear, especially around the batten pockets and bolt rope.
- g)** Make sure that all shackles, pins and sharp objects that the spinnaker might travel over are well taped (preferably using PVC tape). Un-taped shackles or frayed wires are the most common cause of major tears in spinnakers.

**Knot #1**



**Knot #2**



**Knot #3**

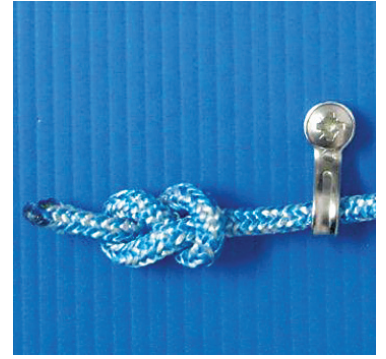

**Knot #4**



**Knot #5**



**Knot #6**



**Knot #1 - Knot on knot**

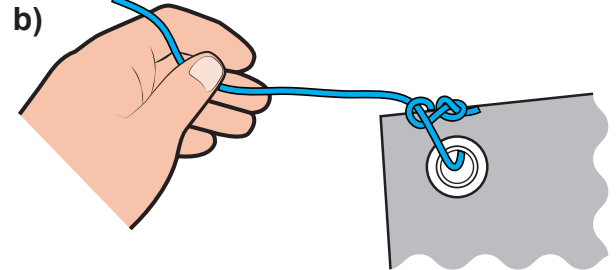
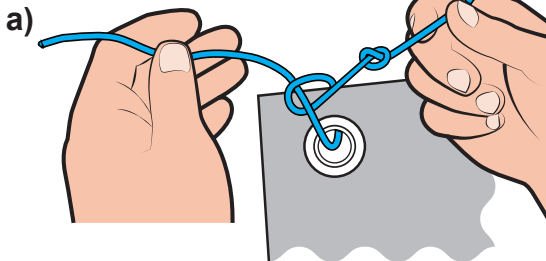

**Knot #2 - Bowline**

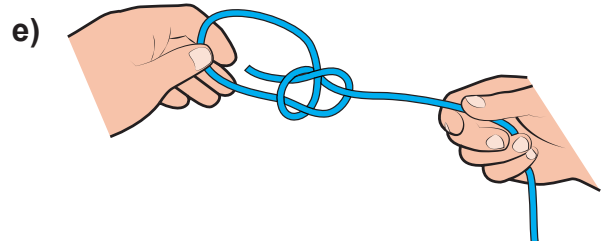
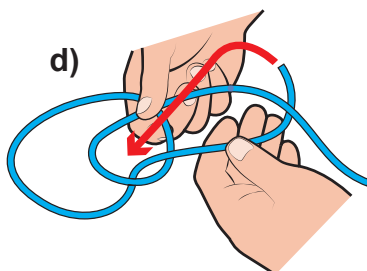
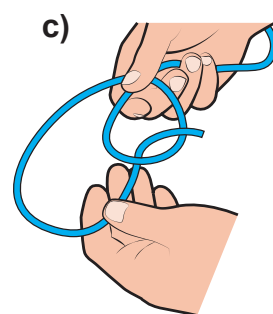
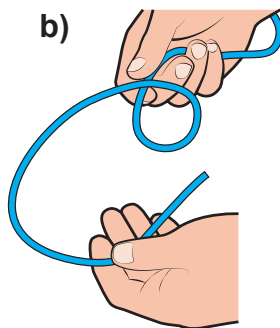
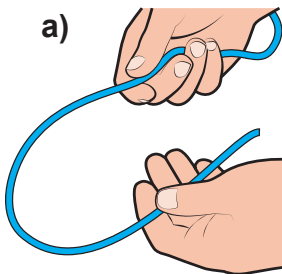

**Knot #3 - Figure of eight**

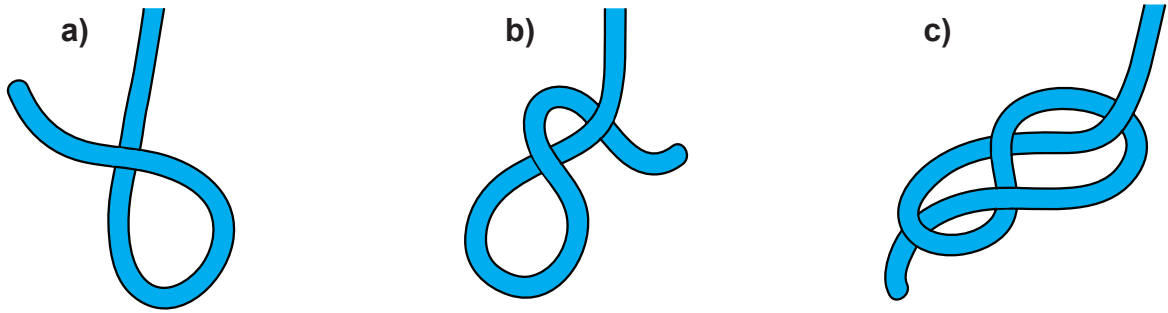

**Knot #4 - Overhand knot**

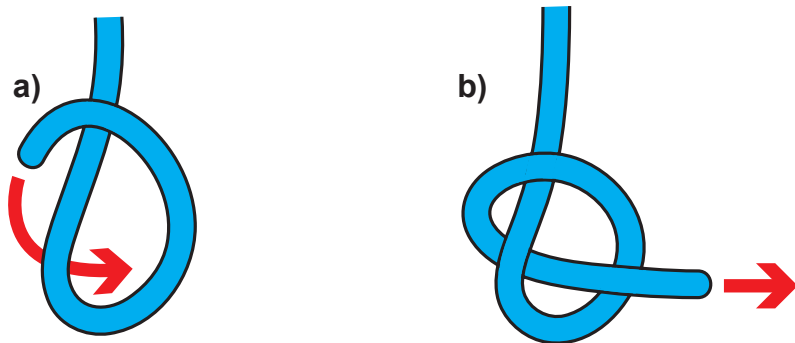

**Knot #5 - Double sheet bend**

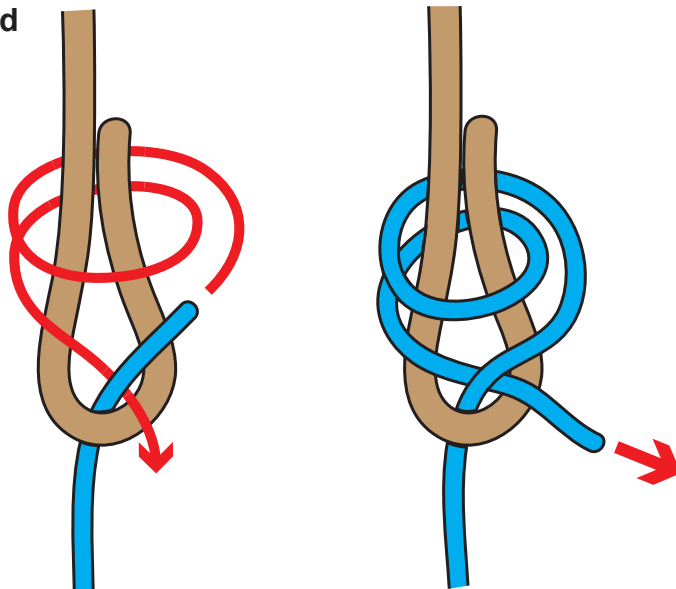

**Knot #6 - Cow hitch**

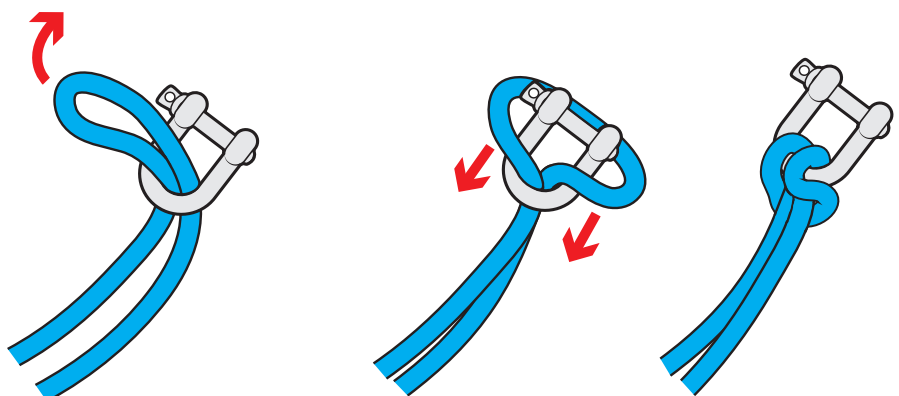

1. This warranty is given in addition to all rights given by statute or otherwise.
2. LDC Racing Sailboats warrants all boats and component parts manufactured by it to be free from defects in materials and workmanship under normal use and circumstances, and the exercise of prudent seamanship, for a period of twelve (12) months from the date of \ commissioning by the original owner. The owner must exercise routine maintenance and care.
3. This warranty does not apply to defects in surface coatings caused by weathering or normal use and wear.
4. This warranty does not apply if the boat has been altered, modified, or repaired without prior written approval of LDC Racing Sailboats. Any changes to the hull structure, deck structure, rig or foils without the written approval of LDC Racing Sailboats will void this warranty.
5. The use of the boat for commercial purposes shall void this warranty.
6. Warranty claims for materials or equipment not manufactured by LDC Racing Sailboats can be made directly to the relevant manufacturer. LDC Racing Sailboats warrants that these parts were installed correctly and according to the instructions provided by the manufacturer.
7. Warranty claims shall be made to LDC Racing Sailboats as soon as practicable and, in any event, within 28 days upon discovery of a defect. No repairs under warranty are to be undertaken without written approval of LDC Racing Sailboats.
8. Upon approval of a warranty claim, LDC Racing Sailboats may, at its expense, repair or replace the component. In all cases, the replacement will be equal in value to the original component.
9. Due to the continuing evolution of the marine market, LDC Racing Sailboats reserves the right to change the design, material, or construction of its products without incurring any obligation to incorporate such changes in products already built or in use.