

RS 400

Rigging Guide

Cunningham Setup V1



PLEASE FOLLOW ASSEMBLY GUIDE IN THE CORRECT ORDER

ROOSTER[®]

R A C E R E A D Y

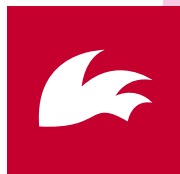

Pack contents:

- 1 x CamCleave CL221 Dinghy Leech Line Cleat
- 1 x 3mm Rope x 1m Length

1)

Raise the sail into position.
Then get the leech line cleat
and position it between the
cringle on the sail and the
hard eye.

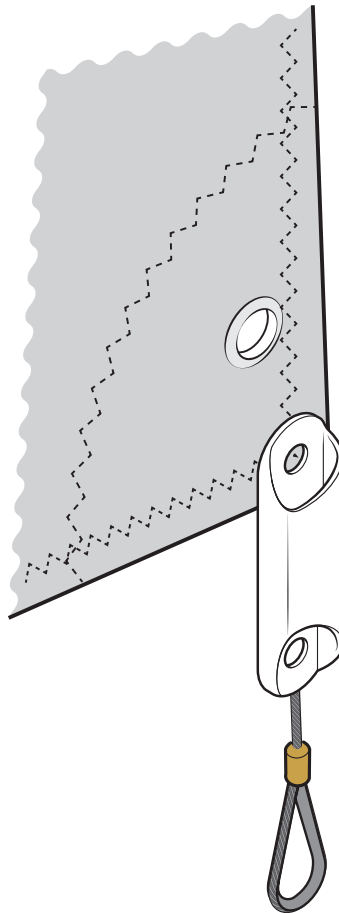

2)

Attached the rope to the hard eye using a knot on knot.

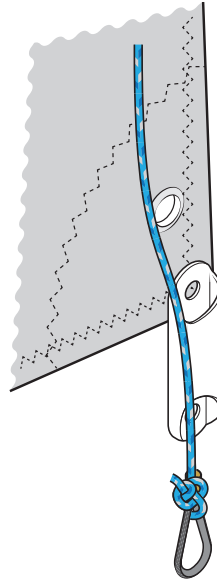

3)

Then take a round turn through the fixing lower hole on the cleat. Get the cleat as close to the fixed eye as possible.

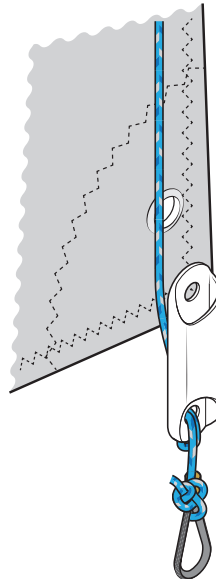

4)

The put in another round turn in the upper fixing hole in the cleat.

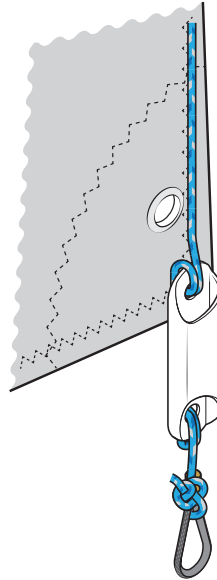

5)

Pass the rope through the cringle in the sail and then pass it through the hard eye.

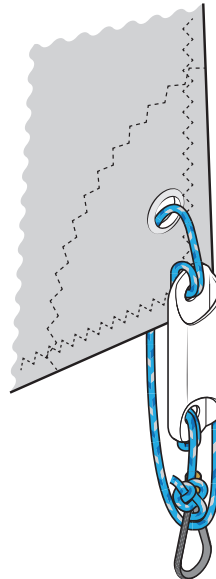

6)

The take the rope back through the cringle.
Make sure the loops are not crossed or
tangled and run free.

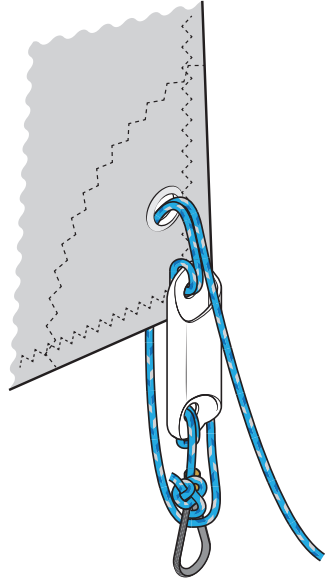

7)

Finally pass the rope down through the cleat
and into the jammer. You can now tension
the cunningham to your specification.

